



SUPEX



2023

**PRODUCT
CATALOGUE**

WELCOME

to the Supex Products 2023 catalogue!

With almost 50 years of industry and customer experience, the Supex Products team are pleased to share the latest information on our product range. We invite you to take a look around, as there's plenty to see of both new and classics. Enjoy!

*From the team at **SUPEX PRODUCTS***



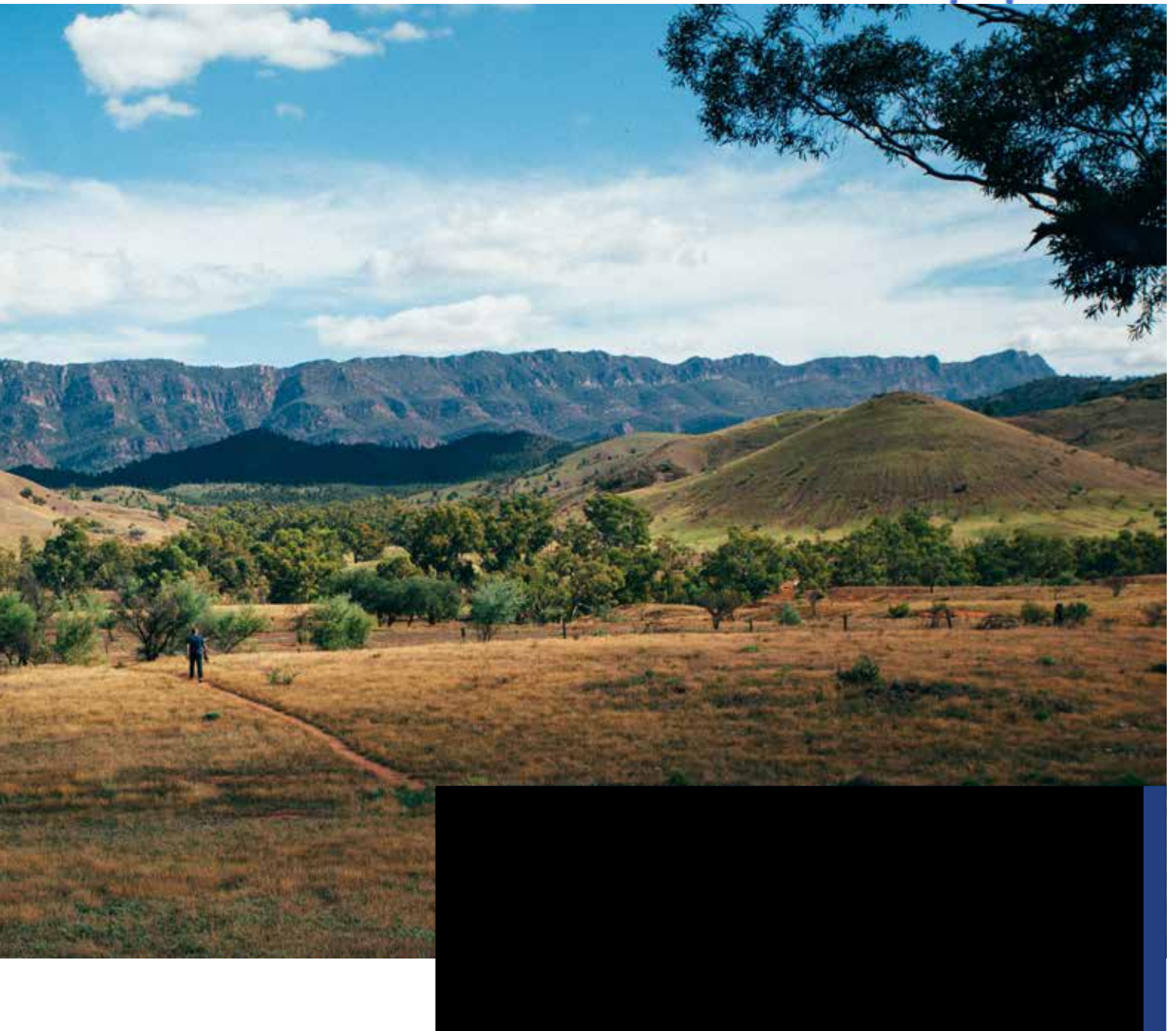
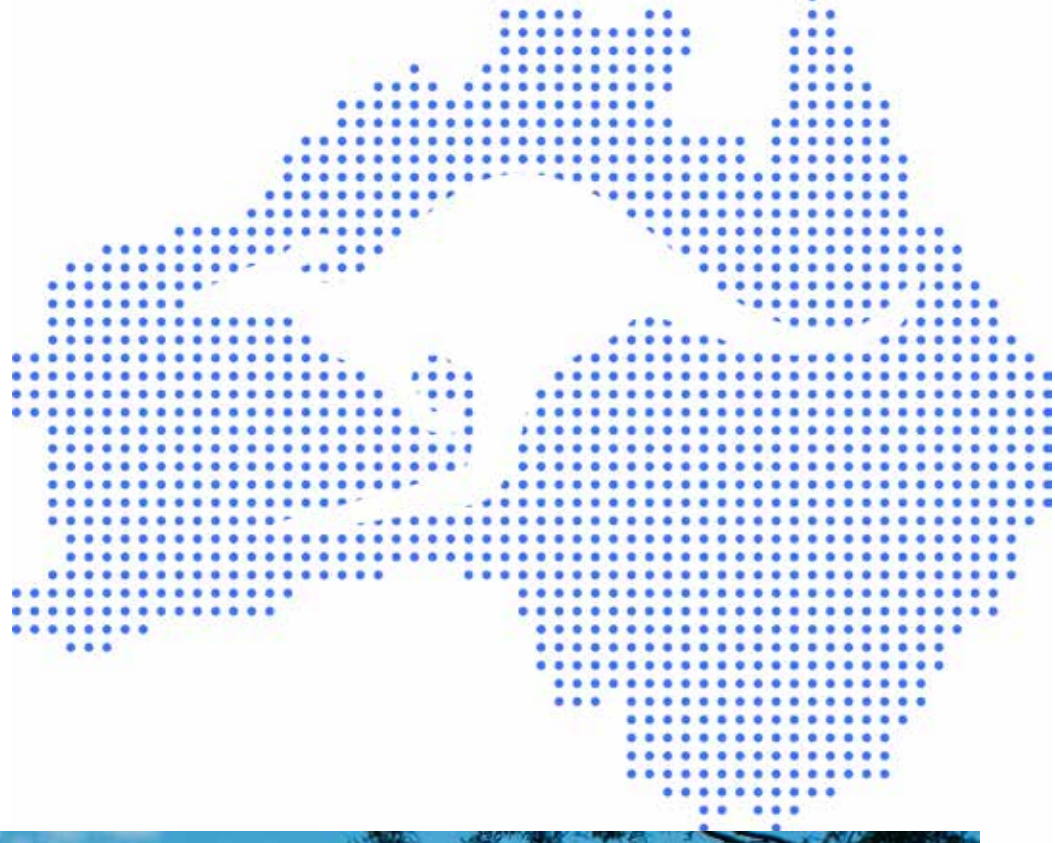



OUR VISION

It is our vision for you to
have the experience of a
lifetime, and a lifetime of
experiences.



OUR MISSION

**It is our mission to serve
you as a trusted trade
partner, supporting you
through consistent,
reliable and timely service.**



TOUR & RV

RV ESSENTIALS & ACCESSORIES

8

RV & TRAILER HARDWARE

26

CARAVAN AWNING & ACCESSORIES

36

ENSUITE

46

ELECTRICAL & 12V

51



RV ESSENTIALS & ACCESSORIES



WHEEL RAMPS & CHOCKS	9	COLLAPSIBLES	16
CARAVAN HOSE & FITTINGS	10	CARAVAN ANNEXE MATTING	20
HOSE FITTINGS & LEAD BAGS	11	POLE HOLDER	22
CLOTHES AIRERS	12	POP TOP SUPPORT	23
CARAVAN STARTER PACKS	13	CARAVAN ACCESSORIES	24
CARAVAN STEPS	14		

WHEEL RAMPS & CHOCKS



SINGLE AXLE WHEEL LEVELLING RAMP



CODE: SRWLS

- To suit single axle vans
- Weight Rating: 5 tonnes
- Includes carry bag, two ramps, two chocks

Dimensions:
560mm (l) x 200mm (w) x 130mm (h)

DUAL AXLE WHEEL LEVELLING RAMP



CODE: SRWLD

- To suit dual axle vans
- Weight Rating: 5 tonnes
- Includes carry bag, two ramps, two chocks

Dimensions:
430mm (l) x 195mm (w) x 90mm (h)

WHEEL CHOCK



CODE: SRWWCH

- Wheel chock with rubber grip along base

Dimensions:
210mm (l) x 120mm (w) x 110mm (h)

DUAL AXLE WHEEL CHOCK



CODE: SRWWCHD

- Interlocking poly wheel chock for tandem wheel caravans
- Separable for single wheel caravans
- Rubber grip along base

Dimensions:
450mm (l) x 209mm (w) x 119mm (h)

RV LEVEL BLOCK SET



CODE: SRWLCHB

- Six piece set to customise ramp height to suit ground and vehicle
- Includes carry bag
- Made from HDPE and rubber

Dimensions:
215mm (l) x 215mm (w) x 40mm (h)

CARAVAN HOSE & FITTINGS



DRINKING WATER HOSE



CODE: DRW10
10m coil hose, fittings not inc.
CODE: DRW20
20m coil hose, fittings not inc.
CODE: DRW10HF
10m coil hose, fittings inc. tap ready
CODE: DRW20HF
20m coil hose, fittings inc., tap ready

- Food grade drinking water hose, 12mm diameter



DRINKING WATER HOSE - BLACK



CODE: DRW1230
12mm dia. x 30m coil
CODE: DRW2530
25mm dia. x 30m coil

- Food grade drinking water hose, black

DRINKING WATER HOSE FITTINGS



1. CODE: HC4035
Hose repairer, 12mm
2. CODE: HC4011
Sprinkler adaptor, 19mm BSP tail
3. CODE: HC4111
Hose connector, 12mm
4. CODE: HC4018
Tap nut adaptor, 19mm and 25mm
5. CODE: HCSETB
Four piece brass hose fitting set; suits 12mm hose



SULLAGE HOSE



CODE: SUL2510 | 25mm dia. x 10m coil
CODE: SUL2810 | 28mm dia. x 10m coil
CODE: SUL3210 | 32mm dia. x 10m coil
CODE: SUL3810 | 38mm dia. x 10m coil

- For effective grey water drainage
- Smooth bore style reduces particle blockage
- Strong, flexible material prevents holes and leaks

EXTRA FLEXIBLE SULLAGE HOSE



CODE: SUL5F | 25mm dia. x 5m coil

- Interlockable extra flexible sullage hose
- With 40mm in-line adaptor
- Strong material prevents holes and leaks

HOSE FITTINGS & LEAD BAGS



SULLAGE HOSE FITTINGS



- 1. CODE: SH25D | Director, 25mm
- 2. CODE: SH25J | Joiner, 25mm
- 3. CODE: SH25NT | Nut & tail, 25mm
- 4. CODE: SH1425D | Director, 14mm/25mm
- 5. CODE: SH32D | Director, 32mm
- 6. CODE: SH32NT | Nut & tail, 32mm
- 7. CODE: SH38NT | Nut & tail, 38mm
- 8. CODE: SH32J | Joiner, 32mm
- 9. CODE: SH38J | Joiner, 38mm

- 10. CODE: SH38D | Director, 38mm
- 11. CODE: SH4020RN | Reducing nipple, 40mm/20mm
- 12. CODE: SH4025RN | Reducing nipple, 40mm/25mm
- 13. CODE: SH4032RN | Reducing nipple, 40mm/32mm
- 14. CODE: SH4020RB | Reducing bush, 40mm/20mm
- 15. CODE: SH4025RB | Reducing bush, 40mm/25mm

- 16. CODE: SH4032RB | Reducing bush, 40mm/32mm
- 17. CODE: HCATA | American thread adaptor, 1 1/16"
- 18. CODE: SHDC25 | Dust cap to suit 25mm tube
- 19. CODE: SHCAM | CAM fitting, fits 25mm - 38mm
- 20. CODE: SHCAMP | Male fitting to suit SHCAM

SMALL HOSE BAG



CODE: SHB
 - Small hose bag to suit 10m fresh water hose or 5m sullage hose
 Dimensions: 370mm dia.

LARGE HOSE BAG



CODE: LHB
 - Large hose bag to suit 20m fresh water hose or 10m sullage hose
 Dimensions: 500mm dia.

ELECTRICAL LEAD BAG



CODE: LB10
 - Holds up to 20m of extension lead
 Dimensions: 370mm dia.

CLOTHES AIRERS



EASY HANG CLOTHESLINE

- Stainless steel easy hang clothesline
- Includes one line per pack
- Note: pictured with two lines



- CODE: CLSS8 | To suit 8' awning
- CODE: CLSS9 | To suit 9' awning
- CODE: CLSS10 | To suit 10' awning
- CODE: CLSS11 | To suit 11' awning
- CODE: CLSS12 | To suit 12' awning
- CODE: CLSS13 | To suit 13' awning
- CODE: CLSS14 | To suit 14' awning
- CODE: CLSS15 | To suit 15' awning
- CODE: CLSS16 | To suit 16' awning
- CODE: CLSS17 | To suit 17' awning
- CODE: CLSS18 | To suit 18' awning
- CODE: CLSS19 | To suit 19' awning
- CODE: CLSS20 | To suit 20' awning
- CODE: CLSS21 | To suit 21' awning
- CODE: CLSS22 | To suit 22' awning
- CODE: CLSS23 | To suit 23' awning
- CODE: CLSS24 | To suit 24' awning
- CODE: CLSS25 | To suit 25' awning

PEGLESS CLOTHESLINE

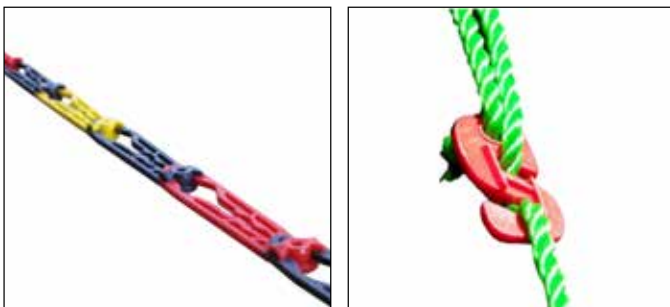

CODE: PGLC

- Innovative design that eliminates the need for pegs
- Quick set up, extends to 2m length or folds neatly
- Includes 1 x 2m clothesline, 2 x 550mm heat sealed cords, 1 x stainless steel spring, 1 x Ezyclip tensioner

FOLDING CLOTHES AIRER



CODE: CD2

- Strong, lightweight aluminium frame with tri-leg design for maximum stability
- Collapsible for easy transportation
- Includes carry bag and ground pegs

Dimensions:

Diagonal: 150cm x 150cm (w)

Legs: 96cm (w) / Assembled: 140 - 145cm (h)

CARAVAN STARTER PACKS



CUSTOMISED CARAVAN STARTER PACKS

Customised Caravan Starter Packs designed to suit your van style and your customer's needs.

Develop every aspect of the starter pack, from hose length and diameter, to toilet chemical type and levelling ramp style.

Includes:

- Your choice of products, in the sizes and quantities you wish
- Reusable bag or sturdy storage container as packaging
- Customised label with your own branding

Not sure where to start? Take a look at our pre-designed Starter Packs below:

Fully
customised

Adjust pack
items to your
requirements

Include your
branding



STANDARD CARAVAN STARTER PACK



CODE: SCSP

Contains:

- 1 x 10m drinking water hose with fittings
- 1 x 10m sullage hose, 25mm dia.
- 1 x 10m, 15amp caravan lead
- 1 x small hose bag
- 1 x large hose bag
- 1 x electrical lead bag

Comes in a reusable bag or container

DELUXE CARAVAN STARTER PACK



CODE: DCSP

Contains:

- 1 x 10m drinking water hose with fittings
- 1 x 10m sullage hose, 25mm dia.
- 1 x 10m, 15amp caravan lead
- 1 x small hose bag
- 1 x large hose bag
- 1 x electrical lead bag
- 1 x T-level
- 1 x levelling ramp set

Comes in a reusable bag or container

CARAVAN STEPS



PLASTIC FIXED CARAVAN STEP

CODE: STP2

- Durable plastic fixed step
- Weight Rating: 80kg

Dimensions: 345mm (d) x 500mm (w) x 230mm (h)



HEAVY DUTY ADJUSTABLE STEP

CODE: STP4

- Heavy duty steel frame with folding legs
- Non-slip tread
- Four stage height adjustment, up to 220mm high
- Weight Rating: 300kg

Dimensions: 370mm (d) x 480mm (w) x 220mm (h)



TWO STAGE FOLDING STEP

CODE: DBSP

- Two stage folding step with zinc finish
- Weld or bolt on to caravan or camper trailer
- Unit weight: 11kg
- Weight Rating: 150kg

Open Dimensions: 750mm (d) x 535mm (w) x 180mm (h)

Closed Dimensions: 300mm (d) x 535mm (w) x 180mm (h)



CARAVAN STEPS



ALUMINIUM CARAVAN STEP



CODE: STP3

- Aluminium frame with folding legs
- Non-slip tread
- Weight Rating: 150kg

Dimensions: 300mm (d) x 480mm (w) x 220mm (h)

ALUMINIUM CARAVAN STEP - BLACK



CODE: STP3B

- Black aluminium frame with folding legs
- With luminous strip & non-slip tread
- Weight Rating: 150kg

Dimensions: 300mm (d) x 480mm (w) x 220mm (h)

TWO STAGE ALUMINIUM STEP



CODE: STP6

- Two stage step, folds flat for easy storage
- Weight Rating: 150kg

Step Dimensions: 225mm (d) x 350mm (w)
Overall Height: 380mm
Lower Step Height: 180mm

TWO STAGE ALUMINIUM STEP - BLACK



CODE: STP6B

- Black two stage step, folds flat for easy storage
- With luminous strip
- Weight Rating: 150kg

Step Dimensions: 225mm (d) x 350mm (w)
Overall Height: 380mm
Lower Step Height: 180mm

COLLAPSIBLE CONTAINERS



ROUND CONTAINERS - FOUR PACK

CODE: CLP6

- Set of four round containers
- Dishwasher safe
- Collapsed height: 120mm stacked

400mL - 120mm (dia.) x 64mm (h)
600mL - 140mm(dia) x 64mm (h)
880mL - 160mm (dia.) x 69mm (h)
1250mL - 190mm (dia.) x 74mm (h)



RECTANGLE CONTAINERS - FOUR PACK

CODE: CLP12

- Set of four rectangular containers
- Dishwasher safe
- Collapsed height: 120mm stacked

350mL - 83mm (d) x 118mm (w) x 64mm (h)
540mL - 93mm (d) x 151mm (w) x 64mm (h)
800mL - 107mm (d) x 172mm (w) x 64mm (h)
1200mL - 122mm (d) x 210mm (w) x 74mm (h)



RECTANGLE CONTAINERS - TWO PACK

CODE: CLP21

- Set of two rectangular containers
- Dishwasher safe
- Collapsed height: 100mm stacked

1500mL - 140mm (d) x 230mm (w) x 70mm (h)
1800mL - 160mm (d) x 250mm (w) x 70mm (h)





COLLAPSIBLE BOWL



CODE: CLP2

- Collapsible bowl for multi-purpose use

Dimensions: 380mm (dia.) x 160mm (h)
Collapsed height: 50mm

SINGLE HANDLE COLANDER



CODE: CLP5

- Made from silicone and plastic

Dimensions:

Handle to tip - 360mm
Bowl - 230mm (dia.) x 95mm (h)
Collapsed height: 40mm

DOUBLE HANDLE COLANDER



CODE: CLP29 - BLUE | CLP30 - GREY

- Dishwasher safe
- Can be used as a steamer, fits inside 1.5L collapsible saucepan

Dimensions: 200mm (dia.) x 85mm (h)
Collapsed height: 35mm

DISH DRAINER



CODE: CLP1

- Made from silicone and plastic

Dimensions: 315mm (d) x 365mm (w) x 125mm (h)
Collapsed height: 50mm

COLLAPSIBLE COOKWARE



COLLAPSIBLE SAUCEPAN

CODE: CLP13 | Blue, 1L. 160mm (dia.) x 90mm (h) - open

CODE: CLP14 | Blue, 1.5L. 200mm (dia.) x 85mm (h) - open

CODE: CLP15 | Blue, 3L. 240mm (dia.) x 125mm (h) - open

CODE: CLP16 | Grey, 1L. 160mm (dia.) x 90mm (h) - open

CODE: CLP17 | Grey, 1.5L. 200mm (dia.) x 85mm (h) - open

CODE: CLP18 | Grey, 3L. 240mm (dia.) x 125mm (h) - open

- Collapsible, dishwasher safe saucepan for use on stovetop, hob or cooker

- Anti-slip lid edge design

- Made from stainless steel, silicone and glass

- Collapsed height: 50mm

Note: Not suitable for induction cooktops



COLLAPSIBLE FRYPAN

CODE: CLP31 - BLUE | CLP32 - GREY

- Collapsible frying pan for use on stovetop, hob or cooker

- Non-stick stainless steel surface with folding handle

- Collapsed height: 58mm

Note: Not suitable for induction cooktops

Dimensions: 240mm (dia.) x 85mm (h) - open



COLLAPSIBLE KETTLE

CODE: CLP19 - BLUE | CLP20 - GREY

- Collapsible, dishwasher safe kettle for use on stovetop, hob or cooker

- Made from stainless steel, silicone and PA

- Collapsed height: 50mm

Note: Not suitable for induction cooktops

Volume: 1.2L

Dimensions: 70mm (d) x 195mm (w) x 225mm (h)



COLLAPSIBLE TUBS & BASKETS



RECTANGLE DISH



CODE: CLP3

Dimensions:
270mm (d) x 370mm (w) x 120mm (h)

Collapsed height: 50mm

BASIN WITH HANDLES



CODE: CLP9

Dimensions:
285mm (d) x 380mm (w) x 140mm (h)

Collapsed height: 50mm

RECTANGLE TUB



CODE: CLP27

Dimensions:
230mm (d) x 320mm (w) x 205mm (h)

Collapsed height: 60mm

WASH TUB/SINK



CODE: CLP7

- With draining hole
Dimensions:
300mm (d) x 320mm (w) x
175mm (h)
Collapsed height: 50mm

BUCKET



CODE: CLP4 | 10L

Dimensions:
330mm (dia.) x 250mm (h)

Collapsed height: 50mm

SMALL BASKET



CODE: CLP8

Dimensions:
375mm (d) x 500mm (w) x
205mm (h)

Collapsed height: 60mm

LARGE BASKET



CODE: CLP28

Dimensions:
460mm (d) x 610mm (w) x
270mm (h)

Collapsed height: 85mm

CARAVAN ANNEXE MATTING



PVC FOAM CARPET

GREY



GREEN



BLUE



CODE: FC1 | Roll; 2.50m (w) x 30m (l)

CODE: FC2 | 2.50m (w) x 3.00m (l)

CODE: FC3 | 2.50m (w) x 3.50m (l)

CODE: FC4 | 2.50m (w) x 4.00m (l)

CODE: FC5 | 2.50m (w) x 4.50m (l)

CODE: FC6 | 2.50m (w) x 5.00m (l)

CODE: FC7 | 2.50m (w) x 5.50m (l)

CODE: FC8 | 2.50m (w) x 6.00m (l)

CODE: FC9 | 2.50m (w) x 7.00m (l)

Premium quality, heavy duty PVC foam carpet for use under caravan and camper trailer annexes. The design provides comfort underfoot and allows sand and dirt to fall through whilst ensuring minimal damage to grass underneath.

- Low maintenance; shake and wipe clean
- Non-slip, UV resistant design
- Mould and mildew resistant
- Manufactured from PVC foam mesh
- Includes carry bag

MESH GROUND MATTING



CODE: MGM8X8 | 8ft (w) x 8ft (l) | 2.40m (w) x 2.40m (l)

CODE: MGM10X10 | 10ft (w) x 10ft (l) | 3.00m (w) x 3.00m (l)

CODE: MGM10X20 | 10ft (w) x 20ft (l) | 3.00m (w) x 6.00m (l)

CODE: MGM12X12 | 12ft (w) x 12ft (l) | 3.70m (w) x 3.70m (l)

Economy mesh ground matting for use under caravan and camper trailer annexes. Mesh-style matting allows the grass underneath to breathe whilst providing protection underfoot.

- Reinforced with eyelets at 80cm intervals
- Can be used for under-tent floor saver
- UV stabilised
- Manufactured from 180GSM shade cloth
- Includes carry bag

CARAVAN ANNEXE MATTING

SUREMAT

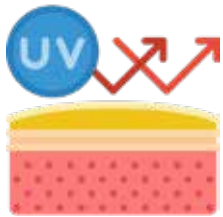

UV RESISTANT



EASY CARE



MOULD & MILDEW RESISTANT



ENVIRONMENTALLY FRIENDLY

CODE: SMAT3 | 2.45m (w) x 3.00m (l)

CODE: SMAT4 | 2.45m (w) x 4.00m (l)

CODE: SMAT5 | 2.45m (w) x 5.00m (l)

CODE: SMAT6 | 2.45m (w) x 6.00m (l)

The ultimate, multi-purpose matting for caravanning, annexe flooring and campsite covering. SureMat is fabricated with a superior, dynamic weave. Manufactured with strong, lightweight material, this matting also features special anti-slip properties.

- Can be used with or without peg fastening
- Easy care and low maintenance, simply shake off dirt and wipe clean if necessary
- Environmentally friendly with innovative, breathable design allowing grass to thrive underneath
- UV resistant
- Mould and mildew resistant
- Includes tent pegs and carry bag

POLE HOLDER



POLE HOLDER

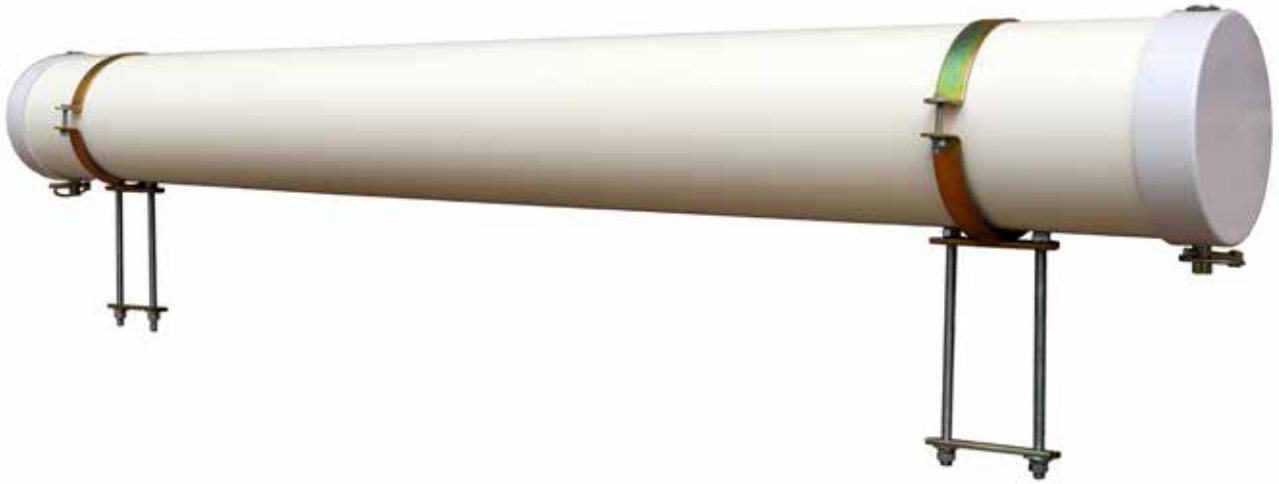

PC220 suitable
for assembled
Secura Bar



CODE: PC160 | 150mm (dia.) x 1.60m (l)
CODE: PC180 | 150mm (dia.) x 1.80m (l)
CODE: PC200 | 150mm (dia.) x 2.00m (l)
CODE: PC220 | 150mm (dia.) x 2.20m (l)

- Heavy duty plastic pole holder for tent poles, anti-flap kits and fishing rods
- Easily lockable on both ends; remove the Quik clips and add padlocks
- Can be fitted to vehicle roof rack
- Mounting brackets included
- Made from UPVC
- Four sizes available

POP TOP SUPPORT



MOUNTING BRACKETS

CODE: PCMBS

- Mounting brackets for pole carrier
- Comes ready to bolt on to 100mm or 150mm chassis of caravan or camper trailer
- Suits 150mm dia. tubing
- Made from zinc plated steel
- Sold as a pair



POP TOP SUPPORT BAR



CODE: PTS | 22-25mm dia. x 1.2WT white finish - max. 50cm

CODE: PTS2 | 22-25mm dia. x 1.2WT white finish - max. 60cm



POP TOP SUPPORT BAR - JAYCO



CODE: PTSJ

- Specifically designed to suit Jayco pop top vans
- Rubber caps either end

Dimensions:

22mm (dia.) x 1200mm (l)



POP TOP SUPPORT BAR DISPLAY BOX

CODE: PTSDB

- Cardboard display box
- Includes 14 x 50cm Pop Top Support Bars



CARAVAN ACCESORIES



MAGAZINE HOLDER

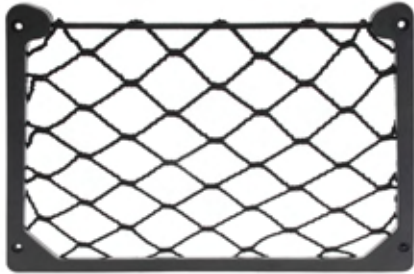

CODE: MGZH

- Storage solution for magazines and books
- Fastens onto the back of RV shelving
- Plastic frame with 5mm dia. elastic rope
- Screws included

Dimensions:
355mm (w) x 185mm (h)

CARAVAN SINK PLUG



CODE: SRCSP25 | Single item

CODE: SRCSP25P | Hang sell pack

- Made from soft rubber

Dimensions:
25mm dia.

T LEVEL



CODE: CL1

- Made from UV resistant high impact plastic

Dimensions:
60mm (l) x 45mm (w) x 15mm (d)

CLIP ON TOWING MIRROR



CODE: CTM1

- Caravan towing mirror clips onto existing mirror
- Mounts on left or right hand side
- Adjustable strap
- One per pack

EASY FIT TOWING MIRROR



CODE: CTM2

- Easy fit fully adjustable towing mirror
- Mounts on left or right hand side
- Ratchet system reduces vibration, increases stability
- Extra large size
- One per pack



FIRST AID KIT

CODE: FIAIK

- Includes the essentials for treating minor injuries
- Contained in a reinforced fabric bag suited to various environments
- Protection against water and dust
- Complies with AS 2675-1983 Portable First Aid Kits for Use by Consumers

Dimensions:

90mm (d) x 140mm (w) x 110mm (h)



CARAVAN FILTER

CODE: SRCR20

- Portable caravan inline water filter with brass hose connectors
- Easily connects to your caravan or motor home
- Incorporates carbon filtration with SilverPlus™ antibacterial technology
- Inhibits bacteria growth and removes unwanted taste, odours and chemicals

Specifications:

Rating: 1 micron

Dimensions: 70mm (dia.) x 300mm (h)

Connection: garden hose 1/2"

Min/max hose flow: 0 - 20 litres per minute

Min/max temperature: 2° - 38°

Min/max pressure: 200 - 860 kPa



SINK HAND PUMP

CODE: SHP1

- Manual pump for RV's
- Double action operation for water on up and down strokes
- Self priming, releases water at any time
- Manufactured from corrosion resistant nylon with polyurethane interior seals and an anodised aluminium barrel
- Includes bonus repair kit

Specifications:

Pump extends 97mm above bench top

Spout extends 140mm from centreline of pump

Maximum bench thickness - 25mm

Bench top to hose fitting distance - 185mm



RV & TRAILER HARDWARE



JOCKEY WHEELS	TRAILER ACCESSORIES
_____ 26	_____ 33
JOCKEY WHEEL ACCESSORIES	JERRY CAN HOLDERS
_____ 29	_____ 34
ADJUSTABLE STANDS & CARAVAN LEGS	GAS BOTTLE HOLDERS
_____ 30	_____ 35
ADJUSTABLE LEGS & ACCESSORIES	
_____ 31	

JOCKEY WHEELS



ECONOMY JOCKEY WHEEL



CODE: JW1E

- Solid rubber wheel with nylon web bore
- Includes clamp
- Unit Weight: 5.2kg
- Static Load Capacity: 500kg

Dimensions:

Wheel - 150mm x 50mm (6" x 2")
Lift - 225mm

EXTRA HEIGHT JOCKEY WHEEL



CODE: JW1EH

- Solid rubber wheel with nylon web bore
- Includes clamp
- Unit Weight: 6.2kg
- Static Load Capacity: 500kg

Dimensions:

Wheel - 150mm x 50mm (6" x 2")
Lift - 225mm

ECONOMY SWIVEL JOCKEY WHEEL



CODE: JW2E

- Solid rubber wheel with nylon web bore
- With pin locking swivel bracket welded in position
- Unit Weight: 6.0kg
- Static Load Capacity: 350kg

Dimensions:

Wheel - 150mm x 50mm (6" x 2")
Lift - 225mm

ECONOMY SWIVEL JOCKEY WHEEL



CODE: JW2UBE

- Solid rubber wheel with nylon web bore
- With pin locking swivel bracket welded in position
- For fixing with U-Bolts (suits 2", 3", 4", 5" & 6" U-Bolts)
- Unit Weight: 6.2kg
- Static Load Capacity: 350kg

Dimensions:

Wheel - 150mm x 50mm (6" x 2")
Lift - 225mm

MEDIUM JOCKEY WHEEL



CODE: JW4Z

- Rubber tyre with zinc plated steel centre and roller bearings
- Includes clamp
- Unit Weight: 6.6kg
- Static Load Capacity: 750kg

Dimensions:

Wheel - 200mm x 55mm (8" x 2")
Lift - 225mm

EXTRA HEIGHT JOCKEY WHEEL



CODE: JW4ZE

- Rubber tyre with zinc plated steel centre and roller bearings
- Includes clamp
- Unit Weight: 8.5kg
- Static Load Capacity: 700kg

Dimensions:

Wheel - 200mm x 55mm (8" x 2")
Lift - 225mm

JOCKEY WHEELS



MEDIUM SWIVEL JOCKEY WHEEL



CODE: JW4ZUB

- Rubber tyre with zinc plated steel centre and roller bearings
- With pin locking swivel bracket welded in position
- For fixing with U-Bolts (suits 2", 3", 4", 5" & 6" U-Bolts)
- Unit Weight: 9.6kg
- Static Load Capacity: 750kg

Dimensions:

Wheel - 200mm x 55mm (8" x 2")

Lift - 225mm

EXTRA HEIGHT JOCKEY WHEEL



CODE: JW9EHD

- Solid cushion tyre with steel centre and bronze bush bore
- 'Pneumatic Look' solid rubber
- Increased capacity; includes H/D clamp
- Unit Weight: 12.2kg
- Static Load Capacity: 850kg

Dimensions:

Wheel - 4.10 / 3.50 x 4 (10")

Lift - 225mm

STANDARD SWIVEL JOCKEY WHEEL



CODE: JWSW-2

- Solid rubber with nylon web bore
- Side winding with pin locking swivel bracket welded in position
- Unit Weight: 7.5kg
- Static Load Capacity: 500kg

Dimensions:

Wheel - 150mm x 50mm (6" x 2")

Lift - 225mm

SWIVEL JOCKEY WHEEL



CODE: JW10S

- Solid cushion tyre with steel centre and bronze bush bore
- 'Pneumatic Look' solid rubber
- With pin locking swivel bracket welded in position
- Unit Weight: 11.1kg
- Static Load Capacity: 850kg

Dimensions:

Wheel - 4.10 / 3.50 x 4 (10")

Lift - 225mm

EXTRA HEIGHT JOCKEY WHEEL



CODE: JWSW-4ZEH

- Rubber tyre with zinc plated steel centre and roller bearings
- Side winding; includes clamp
- Unit Weight: 8.6kg
- Static Load Capacity: 700kg

Dimensions:

Wheel - 200mm x 55mm (8" x 2")

Lift - 225mm

RATCHET DRIVEN SOLID RUBBER JOCKEY WHEEL

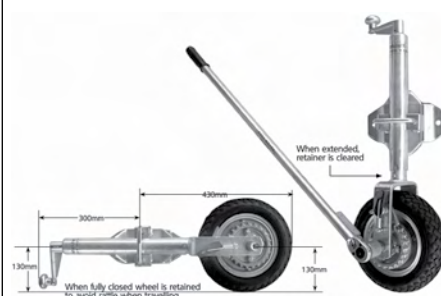

CODE: EM1SP

- Solid cushion tyre with steel centre and bronze bush bore
- With pin locking swivel bracket welded in position
- Unit Weight: 16.5kg
- Static Load Capacity: 750kg

Dimensions:

Wheel - 4.10 / 3.50 x 4 (10")

Lift - 225mm

JOCKEY WHEEL ACCESSORIES



LARGE JOCKEY WHEEL HOLDER



CODE: SRWJCH

- Can be pegged to the ground

Dimensions:
204mm (dia.) x 35mm (h)

RUBBER WHEEL HOLDER



CODE: RWH

- Support cradle for use under 200mm and 250mm jockey wheels
- Unit Weight: 0.55kg

Dimensions:
170mm (l) x 130mm (w) x 40mm (h)

LARGE RUBBER WHEEL HOLDER



CODE: RWHL

- Large support cradle for use under 200mm and 250mm jockey wheels

Dimensions:
200mm (l) x 130mm (w) x 50mm (h)

SOLID RUBBER WHEEL



CODE: JWSRW

- Suits standard jockey wheel
- Unit Weight: 0.97kg

Dimensions:
150mm (dia.) with 13mm nylon web bore

RUBBER TYRE



CODE: RT

- Zinc steel centre finish
- 16mm roller bearing

Dimensions:
200mm dia.

HANDLE ROLL PIN



CODE: JWHRP

- Suits most standard jockey wheels
- Unit Weight: 0.24kg

CLAMP



CODE: JWCL1

- Clamp for jockey wheel
- Suits up to 50mm dia. shank

ADJUSTABLE STANDS & CARAVAN LEGS



STANDARD ADJUSTABLE STAND

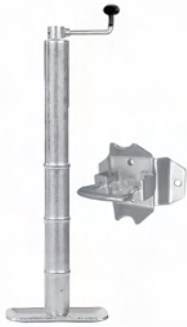

CODE: AS20LB

- With pin locking swivel bracket
- Bracket supplied loose
- Lift: 225mm
- Unit Weight: 6.7kg
- Static Load Capacity: 650kg

MEDIUM DUTY ADJUSTABLE STAND



CODE: ASSW1.4M

- Side winding with loose handle
- Lift: 350mm
- Unit Weight: 15.5kg
- Static load capacity: 1000kg

HEAVY DUTY ADJUSTABLE STAND



CODE: ASSW-DL

- Side winding with drop leg
- Lift: 350mm
- Unit Weight: 11.8kg
- Static Load Capacity: 1500kg

HEAVY DUTY ADJUSTABLE STAND

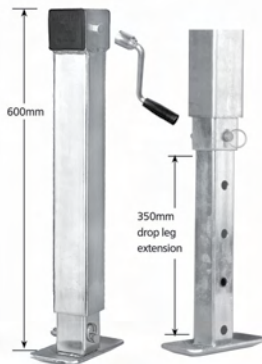

CODE: ASSW-DLLH
WITH LOOSE HANDLE

- As ASSW-DL, with loose handle

FRONT ADJUSTABLE LEG



CODE: ALFP6

- Weld on
- Front; no wheel
- Power thread, slotted type handle fitment
- Unit Weight: 3.6kg
- Length: 600mm

REAR ADJUSTABLE LEG



CODE: ALRP5

- Weld on
- Rear with wheel
- Power thread, slotted type handle fitment
- Unit Weight: 3.5kg
- Length: 500mm

EXTRA LARGE ADJUSTABLE LEG - STEEL FOOT

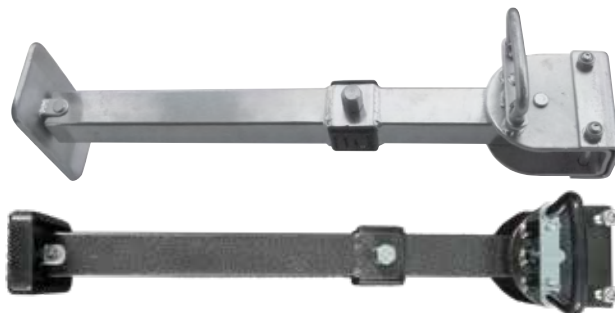

CODE: ALQR4LP | Zinc plated finish
CODE: ALQR4LP-HT | Hammertone finish

- Weld on
- Unit Weight: 6.2kg
- Height: 620mm
- Lift: 180mm

MOUNTING TUBES



CODE: AS-MT

- Swivel for adjustable stands
- Unit Weight: 0.9kg
- Static Load Capacity: 1000kg

ADJUSTABLE LEGS & ACCESSORIES



SMALL ADJUST. LEG WITH PLASTIC FOOT



CODE: ALQR1 | Zinc plated finish
 CODE: ALQR1-HT | H/tone finish
 - Weld on
 - Unit Weight: 4.7kg
 - Height: 400mm / Lift: 120mm

MEDIUM ADJUST. LEG WITH PLASTIC FOOT



CODE: ALQR2 | Zinc plated finish
 CODE: ALQR2-HT | H/tone finish
 - Weld on
 - Unit Weight: 5.1kg
 - Height: 460mm / Lift: 180mm

LARGE ADJUST. LEG WITH PLASTIC FOOT

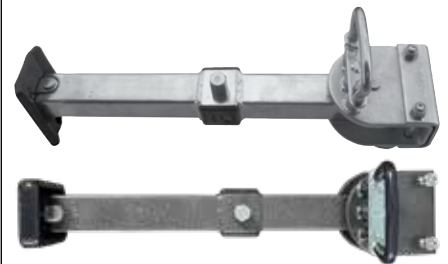

CODE: ALQR3 | Zinc plated finish
 CODE: ALQR3-HT | H/tone finish
 - Weld on
 - Unit Weight: 5.7kg
 - Height: 520mm / Lift: 140mm

SMALL ADJUST. LEG WITH ALUMINIUM FOOT



CODE: ALQR1-AF
 - Unit Weight: 4.7kg
 - Height: 400mm
 - Lift: 120mm

MEDIUM ADJUST. LEG WITH ALUMINIUM FOOT

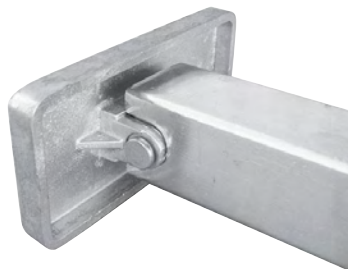

CODE: ALQR2-AF
 - Unit Weight: 5.1kg
 - Height: 460mm
 - Lift: 180mm

LARGE ADJUST. LEG WITH ALUMINIUM FOOT

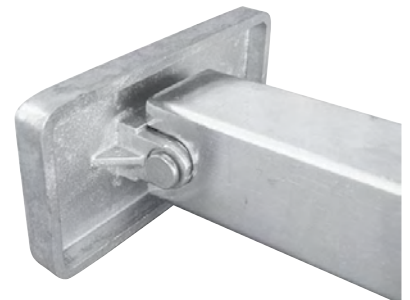

CODE: ALQR3-AF
 - Unit Weight: 5.7kg
 - Height: 520mm
 - Lift: 140mm

ALUMINIUM FOOT



CODE: ALQRAF | Suits ALQR leg

PLASTIC FOOT



CODE: ALQRPF | Suits ALQR leg

PIN FOR REPLACEMENT FOOT

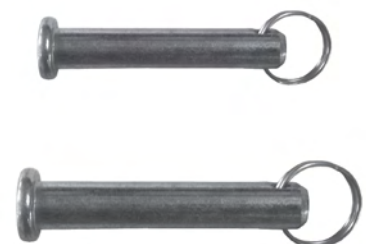

CODE: ALQRPS | Small pin to suit plastic covered feet
 CODE: ALQRPL | Large pin to suit aluminium feet

ADJUSTABLE LEGS & ACCESSORIES



P SERIES HANDLE



CODE: LH2P

- Slotted type / Length: 700mm / Weight: 680g



CODE: LH2PD

- Slotted type, drill style / Length: 570mm / Weight: 500g

HEX HEAD HANDLE



CODE: LH2M

- Hex head type / Length: 700mm / Weight: 840g



CODE: LH2MD

- Hex head type, drill style / Length: 590mm / Weight: 600g

CARAVAN JACK PAD



CODE: SRWJ

- Four piece set

Dimensions:

180mm (d) x 140mm (w) x 50mm (h)

JACK PAD STACKER



CODE: SRWJP

- Four piece set

Dimensions:

145mm (d) x 145mm (w) x 40mm (h)



D - SHACKLES



CODE: DS1 | Small

CODE: DS2 | Medium

CODE: DS3 | Large

DS1

- 1000kg WLL rated; ADR Approved; 10mm

DS2

- 1500kg WLL rated; ADR Approved; 11mm

DS3

- 2000kg WLL rated; ADR Approved; 13mm

BOW SHACKLES



CODE: BSH1 | Small

CODE: BSH2 | Medium

CODE: BSH3 | Large

BSH1

- 1000kg WLL rated; ADR Approved; 10mm

BSH2

- 1500kg WLL rated; ADR Approved; 11mm

BSH3

- 2000kg WLL rated; ADR Approved; 13mm

A TYPE BEARING SET



CODE: MLMAJ

- Japanese; similar to Holden
- Includes small & large bearing, large cup, large cone, A type seal

B TYPE BEARING SET



CODE: MLMBJ

- Japanese slimline or heavy duty bearings, similar to Ford car bearings
- Includes small & large bearing, large cup, large cone, B type seal

TWIN COUPLING LOCK



CODE: TCL

- Twin coupling lock complete with 38mm brass padlock
- Unit weight: 1.86kg

JERRY CAN HOLDERS



JERRY CAN HOLDER



CODE: JCHD

- Zinc plated finish
- Weld on style / metal strap
- Unit Weight: 3.0kg

Inside Dimensions:
180mm (d) x 370mm (w) x 295mm (h)

JERRY CAN HOLDER - FRONT OPENING

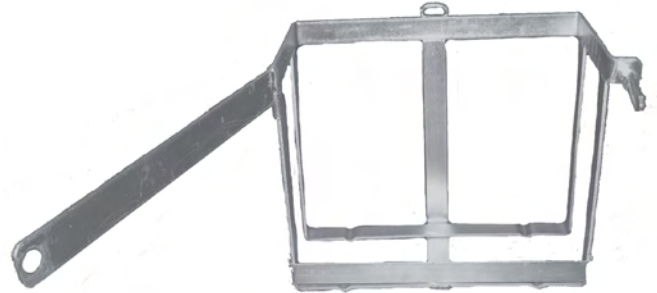

CODE: JCHDO

- Zinc plated finish
- Weld on style / metal strap
- Unit Weight: 3.4kg

Inside Dimensions:
180mm (d) x 370mm (w) x 295mm (h)

JERRY CAN HOLDER - HAMMERTONE FINISH, WITH SIDE FLANGES



CODE: JCHD-SF

- Hammertone finish
- Bolt on style / with side flanges
- Unit Weight: 6.0kg

JERRY CAN HOLDER - HAMMERTONE FINISH, NO SIDE FLANGES



CODE: JCHD-NSF

- Hammertone finish
- Bolt on style / no side flanges
- Unit Weight: 6.0kg

GAS BOTTLE HOLDERS



SMALL GAS BOTTLE HOLDER



CODE: GBHDS

- To suit 4.0kg - 4.5kg gas bottle
- Zinc plated finish, weld on style
- Unit Weight: 1.4kg

MEDIUM GAS BOTTLE HOLDER

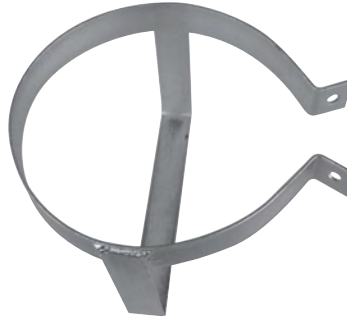

CODE: GBHDM

- To suit 5.0kg 'squat' gas bottle
- Zinc plated finish, weld on style
- Unit Weight: 1.47kg

LARGE GAS BOTTLE HOLDER



CODE: GBHDL

- To suit 9.0kg gas bottle
- Zinc plated finish, weld on style
- Unit Weight: 1.6kg

SMALL, ADJUSTABLE



CODE: AGBHS

- Zinc plated, to suit 4.0kg gas bottle
- Mount brackets for weld on
- Galvanised holder bolted to brackets for easy replacement
- Fully adjustable and lockable
- Unit Weight: 1.86kg

LARGE, ADJUSTABLE

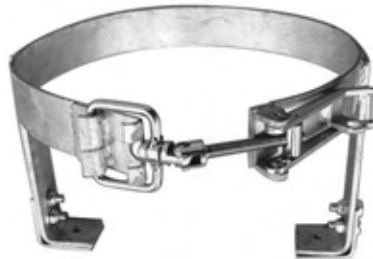

CODE: AGBHL

- Zinc plated, to suit 9.0kg gas bottle
- Mount brackets for weld on
- Galvanised holder bolted to brackets for easy replacement
- Fully adjustable and lockable
- Unit Weight: 2.36kg

RUBBER RING



CODE: AGBHS-RR | Small

CODE: AGBHL-RR | Large

- Place around metal ring of holder to prevent chafing and wear & tear
- 100% rubber ring, black

Note: Gas Bottle Holder not included

ADJUSTABLE GAS BOTTLE HOLDER - FRONT OPENING



CODE: AGBHSO | SMALL

- Suits 4.0kg gas bottle
- Weld on style
- Unit Weight: 1.86kg



CODE: AGBHLO | LARGE

- Suits 9.0kg gas bottle
- Weld on style
- Unit Weight: 2.0kg

CARAVAN AWNING & ACCESSORIES



SECURA BAR
_____ 37

CURVED ROOF RAFTER
_____ 38

SECURA BAR & RAFTER SPARE
PARTS
_____ 39

CARAVAN AWNING ACCESSORIES
_____ 40

PRIVACY SCREENS
_____ 43

SECURA BAR



SUPEX AWNING SECURA BAR

The Supex Products Secura Bar allows you to attach your annexe to a roll out awning. The bar adds stability, preventing the awning from excessive movement in driving wind or rain.

WHITE



CODE: ASWS | Small, Extendable Length: 210cm - 220cm

CODE: ASWM | Medium, Extendable Length: 220cm - 230cm

CODE: ASWL | Large, Extendable Length: 230cm - 240cm

BLACK



CODE: ASBS | Small, Extendable Length: 210cm - 220cm

CODE: ASBM | Medium, Extendable Length: 220cm - 230cm

CODE: ASBL | Large, Extendable Length: 230cm - 240cm

CURVED ROOF RAFTER



POWDERCOATED ALUMINIUM CURVED ROOF RAFTER - WHITE

CODE: 563V | Slight curve, max. length: 243cm (8ft)

CODE: 563VA | Acute curve, max. length: 243cm (8ft)



POWDERCOATED ALUMINIUM CURVED ROOF RAFTER - BLACK

CODE: 563VB | Slight curve, max. length: 243cm (8ft)

CODE: 563VAB | Acute curve, max. length: 243cm (8ft)



SECURA BAR & RAFTER SPARE PARTS



ROOF RAFTER END



CODE: 563RE

- Stainless steel roof rafter end
- Also suits Supex Secura Bar

T-NUT & THUMBSCREW



CODE: 563TS

- Black plastic turning knob with stainless steel T-nut
- Suits Supex Curved Roof Rafter & Supex Secura Bar

CURVED ROOF RAFTER SPIGOT END



CODE: 563SP

- Steel spigot end in moulded black plastic base

SUPEX SECURA BAR SPIGOT END



CODE: ASSP

- Steel spigot end to suit Supex Secura Bar

SUPEX SECURA BAR HANDLE



CODE: ASHA

- Plastic handle for tightening Supex Secura Bar



AWNING ROPE CLIPS



CODE: ARC

- Caravan awning rope clips to fit Dometic (A&E), Carefree and Aussie Traveller awnings
- Stainless steel
- Pack of two

AWNING ROPE CLIP PACK



CODE: ARCPK

- Basic awning set up rope clip pack

Contains:

- Two guy ropes, two awning rope clips, two tent pegs



12V AWNING ROPE CRADLE PAIR



CODE: ARCVP

- Awning rope cradles to suit Carefree 12V roll out awning
- Pack of two



12V AWNING ROPE CRADLE BOX PACK



CODE: ARCVBP

- Basic set up cradle pack to suit Carefree 12V roll out awning

Contains:

- Two cradles, two ground plates, two guy ropes, six tent pegs

CARAVAN AWNING ACCESSORIES



12V AWNING ROPE CRADLE POLE PACK - WHITE

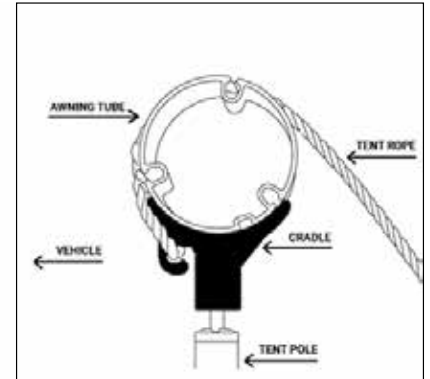

CODE: ARCVPP

- Complete set cradle pack to suit Carefree 12V roll out awning

Contains:

- Two cradles, two ground plates, two guy ropes, six tent pegs, two white 9ft aluminium poles



12V AWNING ROPE CRADLE POLE PACK - BLACK

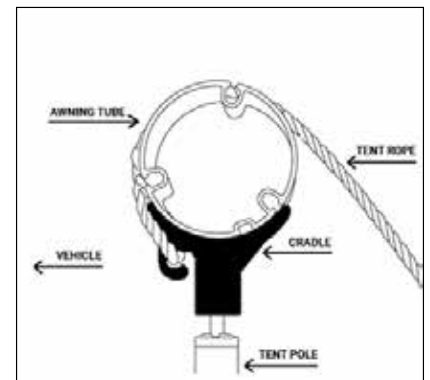

CODE: ARCVPPB

- Complete set cradle pack to suit Carefree 12V roll out awning

Contains:

- Two cradles, two ground plates, two guy ropes, six tent pegs, two black 9ft aluminium poles



AWNING TENSIONER / DE-FLAPPER



CODE: SRDF1 | Large: 1 pack, 203mm (w)

CODE: SRDF2 | Small: 2 pack, 50mm (w)

- Awning tensioner / de-flapper to secure a roll-out awning
- Velcro straps strengthen awning security and reduce wind damage
- Additional strap included for pop top caravans

AWNING BRACKET



CODE: 38AB

- Pole clip for roll out awnings
- Suits 6mm sail track

CARAVAN AWNING SAFETY STRAPS



CODE: CASS

- Velcro caravan awning safety straps
- Secure awning arms whilst travelling
- Pack of two

RUBBER LADDER STRAP



CODE: ANLADD

- Makes tying down annexes easy
- Multiple 'steps' in ladder allow for varying tie-down positions
- Perfect for uneven or rough terrain

Dimensions:
225mm (l) x 22mm (w)

PRIVACY SCREENS



LONG WALL PRIVACY SCREEN

- Long wall privacy screen made to suit the Australian outdoor environment
- Shade rating: 95%
- Made from 199GSM fabric
- Exclusive to Supex Products
- Four year warranty
- Includes guy ropes, tent pegs and D-rings

All long wall & end wall
privacy screens come with a

**4 year
warranty**

GREY



- CODE: SRPS28 | 2.80m (l) x 1.80m (h) | Suits 10' awning
- CODE: SRPS34 | 3.40m (l) x 1.80m (h) | Suits 12' awning
- CODE: SRPS37 | 3.70m (l) x 1.80m (h) | Suits 13' awning
- CODE: SRPS40 | 4.00m (l) x 1.80m (h) | Suits 14' awning
- CODE: SRPS42 | 4.26m (l) x 1.80m (h) | Suits 15' awning
- CODE: SRPS46 | 4.60m (l) x 1.80m (h) | Suits 16' awning
- CODE: SRPS48 | 4.87m (l) x 1.80m (h) | Suits 17' awning
- CODE: SRPS52 | 5.20m (l) x 1.80m (h) | Suits 18' awning
- CODE: SRPS55 | 5.50m (l) x 1.80m (h) | Suits 19' awning

BLACK



- CODE: SRPS28B | 2.80m (l) x 1.80m (h) | Suits 10' awning
- CODE: SRPS34B | 3.40m (l) x 1.80m (h) | Suits 12' awning
- CODE: SRPS37B | 3.70m (l) x 1.80m (h) | Suits 13' awning
- CODE: SRPS40B | 4.00m (l) x 1.80m (h) | Suits 14' awning
- CODE: SRPS42B | 4.26m (l) x 1.80m (h) | Suits 15' awning
- CODE: SRPS46B | 4.60m (l) x 1.80m (h) | Suits 16' awning
- CODE: SRPS48B | 4.87m (l) x 1.80m (h) | Suits 17' awning
- CODE: SRPS52B | 5.20m (l) x 1.80m (h) | Suits 18' awning
- CODE: SRPS55B | 5.50m (l) x 1.80m (h) | Suits 19' awning

END WALL PRIVACY SCREEN - TO SUIT CARAVANS



- CODE: CAEPS | Grey | 1.90m (w) x 2.35m (high end) x 2.09m (low end)
- CODE: CAEPSB | Black | 1.90m (w) x 2.35m (high end) x 2.09m (low end)

- End wall privacy screen made to suit the Australian environment
- Shade rating: 95%
- Made from 199GSM fabric
- Exclusive to Supex Products
- Four year warranty
- Includes guy ropes, tent pegs and D-rings



POP TOP CARAVAN END WALL

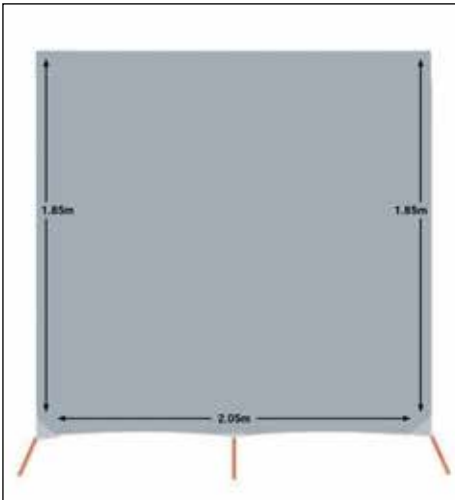

CODE: PTAEPS | Grey | 2.05m (w) x 1.85m (h)

CODE: PTAEPSB | Black | 2.05m (w) x 1.85m (h)

- Shade rating: 95%
- Manufactured from 199GSM fabric
- Exclusive to Supex Products
- Four year warranty
- Includes guy ropes, tent pegs & D-rings

BONUS DROP PRIVACY SCREEN - 1.95M DROP



CODE: SRPSBD37

3.70m (l) x 1.95m (h) | Suits 13' awning

CODE: SRPSBD40

4.00m (l) x 1.95m (h) | Suits 14' awning

CODE: SRPSBD42

4.26m (l) x 1.95m (h) | Suits 15' awning

CODE: SRPSBD46

4.60m (l) x 1.95m (h) | Suits 16' awning

CODE: SRPSBD48

4.87m (l) x 1.95m (h) | Suits 17' awning

CODE: SRPSBD52

5.20m (l) x 1.95m (h) | Suits 18' awning

CODE: SRPSBD55

5.50m (l) x 1.95m (h) | Suits 19' awning

- Bonus drop long wall privacy screen to suit off road caravans
- Shade rating: 95%
- Manufactured from 199GSM fabric
- Exclusive to Supex Products
- Four year warranty
- Includes guy ropes, tent pegs & D-rings



CODE: CAEPS-BD | Grey | 2.10m (w) x 2.49m (high end) x 2.09m (low end)

- Bonus drop end wall privacy screen to suit off road caravans
- Shade rating: 95%
- Manufactured from 199GSM fabric
- Exclusive to Supex Products
- Four year warranty
- Includes guy ropes, tent pegs & D-rings

PRIVACY SCREENS



FIAMMA AWNING PRIVACY SCREEN



SRPSF28

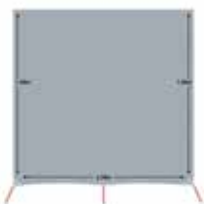

SRPSF33

CODE: SRPSF28 | 2.85m (l) x 1.80m (h) | Suits 3.00m Fiamma F45 awning

CODE: SRPSF33 | 3.35m (l) x 1.80m (h) | Suits 3.50m Fiamma F45 awning

CODE: SRPSF38 | 3.85m (l) x 1.80m (h) | Suits 4.00m Fiamma F45 awning

Privacy screen long wall for Fiamma awning

- Spline; 4mm



SRPSF38



CAEPSF

CODE: CAEPSF | Spline: 4mm | Suits Fiamma F45 awning

Privacy screen end wall for Fiamma awning

- Spline; 4mm

CARAVAN FRIDGE SCREEN



CODE: SRFS | 810mm (w) x 1830mm (h)

CODE: SRFSST | 810mm (w) x 1830mm (h) | Sail track included

- Shades caravan fridge vents to assist performance
- Includes pegs and ropes

TIE DOWN KIT



CODE: CAM1

- Quickly and easily fasten privacy screens
- Provides tension

Includes:

- 5 x bungee cords
- 5 x tent pegs

Tent Peg Dimensions:
6.3mm (dia.) x 225mm (h)

ENSUITE

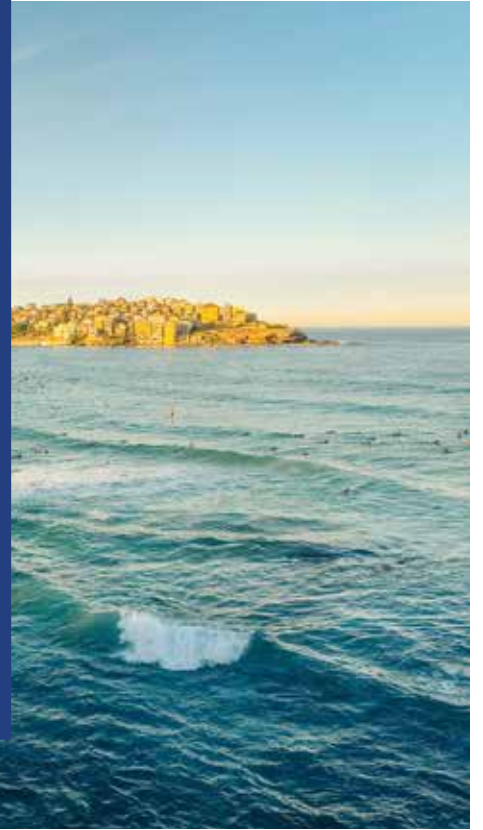

TOILET CHEMICAL SACHETS
_____ 47

STIMEX TOILET CHEMICAL LIQUID
_____ 48

PORTABLE TOILET & CLEANERS
_____ 49

TOILET CHEMICAL SACHETS



PORTA PAK FRESH SCENT



CODE: WL1

- Odour prevention
- Biodegradable & formaldehyde free
- Pack of 15 sachets

PORTA PAK LAVENDER BREEZE



CODE: WL2

- Odour prevention
- Biodegradable & formaldehyde free
- Pack of 15 sachets

PORTA PAK ALPINE FRESH



CODE: WL3

- Removes odours, safe for septic tank
- Biocide & formaldehyde free
- Pack of 15 sachets

PORTA PAK TROPICAL BREEZE



CODE: WL4

- Removes odours, safe for septic tank
- Biocide & formaldehyde free
- Pack of 15 sachets

PORTA PAK COMMANDO



CODE: WL5

- Lubricates valves & seals
- Septic tank safe, dissolvable packet
- Formaldehyde free
- Pack of 4 sachets

PORTA PAK ELEMONATE



CODE: WL6

- Cleans sensors inside grey tank
- Dissolves rapidly
- Biodegradable & formaldehyde free
- Pack of 5 sachets

STIMEX TOILET CHEMICAL LIQUID



CAMP BLUE - 2.5L



CODE: STCB

- High concentrate toilet liquid
- For use in the waste tank of all chemical toilets
- Volume: 2.5L

CAMP BLUE - 1L



CODE: STCB1L

- High concentrate toilet liquid
- For use in the waste tank of all chemical toilets
- Volume: 1L

CAMP FLUSH - 2.5L



CODE: STCF

- Pleasant smelling toilet break down liquid
- For use in the flush tank of all chemical toilets
- Environmentally safe & biodegradable
- Volume: 2.5L

CAMP FLUSH - 1L



CODE: STCF1L

- Pleasant smelling toilet break down liquid
- For use in the flush tank of all chemical toilets
- Environmentally safe & biodegradable
- Volume: 1L

CAMP GREEN - 2.5L



CODE: STCG

- High concentrate toilet liquid
- For use in the waste tank of all chemical toilets
- Environmentally safe & biodegradable
- Volume: 2.5L

CAMP GREEN - 1L



CODE: STCG1L

- High concentrate toilet liquid
- For use in the waste tank of all chemical toilets
- Environmentally safe & biodegradable
- Volume: 1L

PORTABLE TOILET & CLEANERS



PORTABLE TOILET

CODE: PT15

- Pressure control valve and swivel spout for easy emptying
- Auto ventilation
- Single flush nozzle
- Capacity: 15L fresh, 17L waste
- Weight: 3.8kg

Dimensions:

446mm (d) x 380mm (w) x 367mm (h)



CAMP SOFT TOILET PAPER



CODE: STICS

- Rapidly dissolving toilet paper
- For all types of portable toilets
- Pack of 4 rolls

WATER TANK CLEANER



CODE: SWC

- Environmentally friendly concentrate for caravan pipes and water tanks
- Cleans limescale and deposits
- Contains 500mL

CASSETTE TANK CLEANER



CODE: SCTC

- High concentrate cleaning liquid
- For use in the waste tank of chemical and/or portable toilets
- Contains 500mL

PROPOWER PROBIOTIC CASSETTE TANK TREATMENT



CODE: PPC05

- Chemical free cassette tank treatment
- Eliminates odours and reduces biodegradable pollutants
- Non-toxic, 100% natural, beneficial to septic systems
- Volume: 500mL / Provides up to 25 doses

PROPOWER PROBIOTIC GREY WASTEWATER TANK TREATMENT



CODE: PPG05

- Chemical free treatment & preventative maintenance
- Controls odours and digests sludge
- Non-toxic, 100% natural, beneficial to septic systems
- Volume: 500mL / Provides up to 16 doses

ELECTRICAL & 12V



LEADS, ANODE & ACCESSORIES
_____ 51

INTERIOR LED LIGHTING
_____ 52

EXTERIOR LED LIGHTING
_____ 53

LED LIGHTING
_____ 54

LEADS, ANODE & ACCESSORIES

CARAVAN LEADS

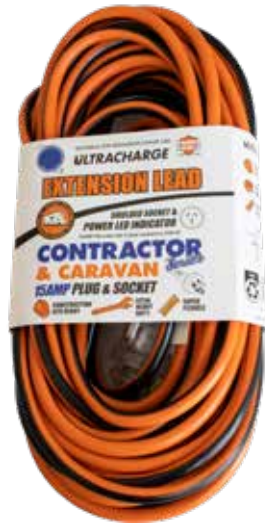

- CODE: EL10 | 10m length
CODE: EL15 | 15m length
CODE: EL20 | 20m length
- Heavy duty caravan extension lead, 15amp plug

ANODE



- CODE: AND1 | Anode, loose
CODE: AND1P | Anode, blister pack
- Magnesium suburban anode
- Designed for suburban RV water heaters
Dimensions: 21mm dia. x 300mm (l)

7 PIN FLAT PLUG



- CODE: EAP7F
- Circuits engraved into outer casing
- Saddle device to secure wiring
- Seven pins rated at 15amps at 12V
- Suitable for 12V and 24V applications

7 PIN FLAT SOCKET



- CODE: EA7FFM
- Circuits engraved into outer casing
- Seven pins rated at 15amps at 12V
- Suitable for 12V and 24V applications

HAIR DRYER



- CODE: HDYR
- Convenient, compact hair dryer for travelling
- Hot and cool air options
- DC motor; 12V car use voltage, 50Hz, 192W
- Includes 1.5m PVC cord

HAIR STYLER



- CODE: HRST
- Convenient hair styler for travelling
- Ceramic plate & PTC heater, heats rapidly to max. 200°C
- LED light indicates ready for use
- 12V car use voltage

OYSTER LIGHT



CODE: SRLED1

- 12V interior roof mount light
- Body colour: white
- Cool white light, 6W

Dimensions: 260mm dia.

ULTRA SLIM LIGHT



CODE: SRLED5 | SRLED27

- Opal panel light with switch
- Body colour: white

Dimensions:

SRLED5 - 127mm dia.
SRLED27 - 216mm dia.

READING LIGHT



CODE: SRLED2

- LED frosted glass swivel light

Dimensions: 106mm (h)

READING LIGHT



CODE: SRLED15B | SRLED15C

- 10-15V programmed reading light
- Crystal glass flexible light
- Dual colour - cool white, blue

Dimensions:

SRLED15B - 160mm (h)
SRLED15C - 139mm (h)

BRIGHT BAR LIGHT



CODE: SRLED22 | SRLED23 | SRLED24 | SRLED25

- 12V milky ultra bright internal LED bar light

Dimensions: (as shown top to bottom)

150mm (l) x 21mm (w) x 12mm (d)
300mm (l) x 21mm (w) x 12mm (d)
450mm (l) x 21mm (w) x 12mm (d)
600mm (l) x 21mm (w) x 12mm (d)

SWIVEL RAIL LIGHT



CODE: SRLED19 | SRLED20 | SRLED 21

- 12V LED internal swivel rail light
- White polycarbonate shell

Dimensions: (as shown top to bottom)

156mm (l) x 27.5mm (w) x 24.5mm (d)
298mm (l) x 27.5mm (w) x 24.5mm (d)
460mm (l) x 27.5mm (w) x 24.5mm (d)

EXTERIOR LED LIGHTING

BARGMAN STYLE



CODE: SRLED6

- Polycarbonate ABS plastic housing
- 35 x LED lights
- Chrome base

NUMBER PLATE LAMP



CODE: SRLEDNPL

Dimensions:
75mm (l) x 30mm (w) x 35mm (h)

AWNING LIGHT - PC



CODE: SRLED8W | White
CODE: SRLED8B | Black

- Available in black and white
- Dimensions:
250mm (l) x 40.5mm (w) x 30mm (h)

AWNING LIGHT - PC



CODE: SRLED9W | White
CODE: SRLED9B | Black

- Available in black and white
- Dimensions:
550mm (l) x 40.5mm (w) x 30mm (h)

CRL360 SERIES: SLIMLINE COMBINATION REAR LAMPS



CODE: RL360DLEDB

- Single, INDICATOR
- 10V - 30V
- Black base

Dimensions:
400mm (l) x 46mm (d) x 15mm (h)



CODE: RL360DLEDC

- Single, INDICATOR
- 10V - 30V
- Chrome base

Dimensions:
400mm (l) x 46mm (d) x 15mm (h)



CODE: RL360SLEDB

- Single, STOP/TAIL
- 10 - 30V
- Black base

Dimensions:
400mm (l) x 46mm (d) x 15mm (h)



CODE: RL360SLEDC

- Single, STOP/TAIL
- 10 - 30V
- Chrome base

Dimensions:
400mm (l) x 46mm (d) x 15mm (h)



CODE: RL360RLEDB

- Single, REVERSE
- 10 - 30V
- Black base

Dimensions:
400mm (l) x 46mm (d) x 15mm (h)



CODE: RL360RLEDC

- Single, REVERSE
- 10 - 30V
- Chrome base

Dimensions:
400mm (l) x 46mm (d) x 15mm (h)



CODE: RL360SDLEDB

- Single, STOP/TAIL/INDICATOR
- 10 - 30V
- Black base

Dimensions:
400mm (l) x 46mm (d) x 15mm (h)



CODE: RL360SDLEDC

- Single, STOP/TAIL/INDICATOR
- 10 - 30V
- Chrome base

Dimensions:
400mm (l) x 46mm (d) x 15mm (h)



CODE: CRL360LEDB

- Combination, STOP/TAIL/IND.
- 10 - 30V
- Black base

Dimensions:
400mm (l) x 82mm (d) x 15mm (h)



CODE: CRL360LEDC

- Combination, STOP/TAIL/IND.
- 10 - 30V
- Chrome base

Dimensions:
400mm (l) x 82mm (d) x 15mm (h)



CODE: CRL360RLEDB

- Combination, STOP/TAIL/IND./REV.
- 10 - 30V
- Black base

Dimensions:
400mm (l) x 82mm (d) x 15mm (h)



CODE: CRL360RLEDC

- Combination, STOP/TAIL/IND./REV.
- 10 - 30V
- Chrome base

Dimensions:
400mm (l) x 82mm (d) x 15mm (h)

CRL260 SERIES: SLIMLINE COMBINATION LAMPS



CODE: RL260DLEDB

- Single, INDICATOR
- 10 - 30V
- Black base

Dimensions:

259mm (l) x 46mm (d) x 15 mm (h)



CODE: RL260SLEDB

- Single, STOP/TAIL
- 10 - 30V
- Black base

Dimensions:

259mm (l) x 46mm (d) x 15 mm (h)



CODE: RL260RLEDB

- Single, REVERSE
- 10 - 30V
- Black base

Dimensions:

259mm (l) x 46mm (d) x 15 mm (h)



CODE: RL260SDLEDB

- Single, STOP/TAIL/INDICATOR
- 10 - 30V
- Black base

Dimensions:

259mm (l) x 46mm (d) x 15 mm (h)



CODE: CRL260RLEDB

- Combination, STOP/TAIL/INDICATOR /REVERSE
- 10 - 30V
- Black base

Dimensions:

259mm (l) x 82mm (d) x 15 mm (h)



CODE: CRL260LEDB

- Combination, STOP/TAIL/INDICATOR
- 10 - 30V
- Black base

Dimensions:

259mm (l) x 82mm (d) x 15 mm (h)

CRL350 SERIES: COMBINATION REAR LAMPS



CODE: CRL350LEDB

- STOP/TAIL/INDICATOR
- Black base

Dimensions:
445mm (l) x 155mm (d) x 40 mm (h)



CODE: CRL350LEDC

- STOP/TAIL/INDICATOR
- Chrome base

Dimensions:
445mm (l) x 155mm (d) x 40 mm (h)



CODE: CRL350CLEDB

- STOP/TAIL/INDICATOR
- Clear lens, black base

Dimensions:
445mm (l) x 155mm (d) x 40 mm (h)



CODE: CRL350CLEDC

- STOP/TAIL/INDICATOR
- Clear lens, chrome base

Dimensions:
445mm (l) x 155mm (d) x 40 mm (h)



CODE: CRL350RLEDB

- Combination, STOP/TAIL/INDICATOR/REVERSE
- Black base

Dimensions:
445mm (l) x 155mm (d) x 40 mm (h)



CODE: CRL350RLEDC

- Combination, STOP/TAIL/INDICATOR/REVERSE
- Chrome base

Dimensions:
445mm (l) x 155mm (d) x 40 mm (h)



CODE: CRL350RCLEDB

- STOP/TAIL/INDICATOR/REVERSE
- Clear lens, black base

Dimensions:
445mm (l) x 155mm (d) x 40 mm (h)



CODE: CRL350RCLEDC

- STOP/TAIL/INDICATOR/REVERSE
- Clear lens, chrome base

Dimensions:
445mm (l) x 155mm (d) x 40 mm (h)

LED LIGHTING

SM8 SERIES: MARKER LAMPS - FRONT, SIDE, REAR



CODE: FM8CLELED

- Clear LED front clearance lamp with reflectors

Dimensions:

90mm (l) x 50mm (d) x 22mm (h)



CODE: RM8RLED

- Red LED rear marker lamp with reflectors

Dimensions:

90mm (l) x 50mm (d) x 22mm (h)



CODE: SM8ALELED

- Amber LED side marker lamp with reflectors

Dimensions:

90mm (l) x 50mm (d) x 22mm (h)

SM13 & SM62 SERIES: MARKER LAMPS



CODE: SM13ALELED

- Amber 'retrofit' LED marker
- Includes 0.5m cable

Dimensions:

120mm (l) x 64mm (d) x 32mm (h)



CODE: SM13RALED

- Red/amber 'retrofit' LED side marker
- Includes 0.5m cable

Dimensions:

120mm (l) x 64mm (d) x 32mm (h)



CODE: FM62CLELED

- Clear LED front clearance marker
- 9 - 33V
- Includes 0.5m cable

Dimensions:

57mm (l) x 35mm (d) x 21mm (h)



CODE: SM62RALED

- Red/amber side marker
- 9 - 33V
- Includes 0.5m cable

Dimensions:

57mm (l) x 35mm (d) x 21mm (h)



CODE: RM62RLED

- Red rear marker
- 9 - 33V
- Includes 0.5m cable

Dimensions:

57mm (l) x 35mm (d) x 21mm (h)



CODE: SM62ALELED

- Amber side marker
- 9 - 33V
- Includes 0.5m cable

Dimensions:

57mm (l) x 35mm (d) x 21mm (h)



CAMP & OUTDOORS

TENT POLES & SPREADER BARS

60

ROPES & PEGS

72

MAINTENANCE & REPAIR

80

BEDDING

86

FURNITURE

90

COOKWARE

96

BEACH & SHELTERS

106

CAMPSITE ACCESSORIES

116



TENT POLES & SPREADER BARS

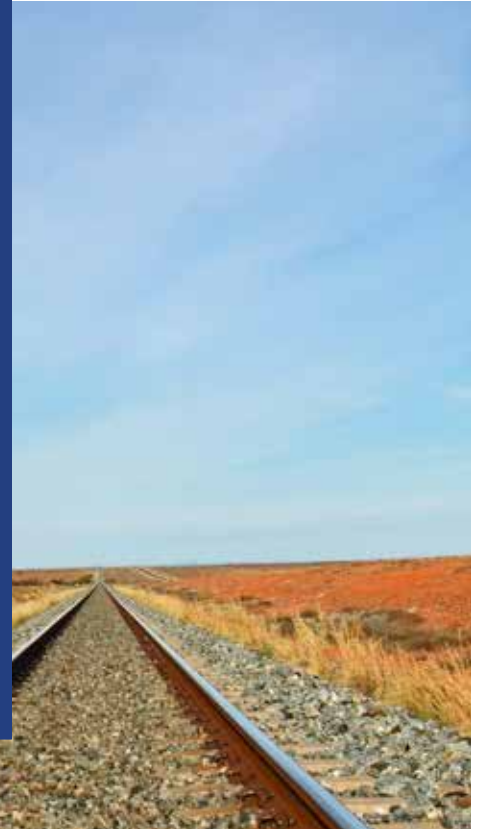

TENT POLES	61	ALUMINIUM SPREADER BARS	67
SPREADER BARS	64	TENT POLE ACCESSORIES	68
ROOF RAILS	65	TORNADO TARPS	71
ALUMINIUM TENT POLES	66		



TENT POLE - T NUT - IMPORTED



CODE: 564Ci | 19-22mm dia. x 0.9WT – max. 183cm (6') | Collapsed length: ~113cm

CODE: 564Di | 19-22mm dia. x 0.9WT – max. 228cm (7'6") | Collapsed length: ~129cm

CODE: 564Ei | 19-22mm dia. x 0.9WT – max. 274cm (9') | Collapsed length: ~149cm



EXTENSION POLE - T NUT - HEAVY DUTY CAP



CODE: 564C | 19-22mm dia. x 0.9WT – max. 183cm (6') | Collapsed length: ~110cm

CODE: 564D | 19-22mm dia. x 0.9WT – max. 228cm (7'6") | Collapsed length: ~122cm

CODE: 564B | 19-22mm dia. x 0.9WT – max. 243cm (8') | Collapsed length: ~133cm

CODE: 564E | 19-22mm dia. x 0.9WT – max. 274cm (9') | Collapsed length: ~146cm

CODE: 564F | 19-22mm dia. x 0.9WT – max. 305cm (10') | Collapsed length: ~169cm



EXTENSION SUPPORT POLE - T NUT - CLIP 1 END



CODE: 564DC | 19-22mm dia. x 0.9WT - max. 228cm (7'6") - clip end | Collapsed length: ~125cm

CODE: 564BC | 19-22mm dia. x 0.9WT - max. 243cm (8') - clip end | Collapsed length: ~136cm

CODE: 564EC | 19-22mm dia. x 0.9WT - max. 274cm (9') - clip end | Collapsed length: ~149cm

CODE: 564FC | 19-22mm dia. x 0.9WT - max. 305cm (10') - clip end | Collapsed length: ~166cm

TENT POLES



EXTENSION SUPPORT POLE - T NUT - SQUARE C-CLIP



CODE: 564DSQC | 19-22mm dia. x 0.9WT – max. 228cm (7'6") - square clip end | Collapsed length: ~125cm

CODE: 564BSQC | 19-22mm dia. x 0.9WT – max. 243cm (8') - square clip end | Collapsed length: ~136cm

CODE: 564ESQC | 19-22mm dia. x 0.9WT – max. 274cm (9') - square clip end | Collapsed length: ~149cm

CODE: 564FSQC | 19-22mm dia. x 0.9WT – max. 305cm (10') - square clip end | Collapsed length: ~166cm



THREE PIECE EXTENSION POLE



CODE: 564H | 19-22-25mm dia. x 0.9WT – max. 243cm (8') | Collapsed length: ~96cm

CODE: 564I | 19-22-25mm dia. x 0.9WT – max. 305cm (10') | Collapsed length: ~116cm

CODE: 564G | 19-22-25mm dia. x 0.9WT – max. 366cm (12') | Collapsed length: ~138cm



EXTENSION POLE - T NUT - THREADED SPIGOT



CODE: 564CT | 19-22mm dia. x 0.9WT - max. 183cm (6') - threaded spigot | Collapsed length: ~110cm

CODE: 564DT | 19-22mm dia. x 0.9WT - max. 228cm (7'6") - threaded spigot | Collapsed length: ~126cm

CODE: 564BT | 19-22mm dia. x 0.9WT - max. 243cm (8') - threaded spigot | Collapsed length: ~133cm

CODE: 564ET | 19-22mm dia. x 0.9WT - max. 274cm (9') - threaded spigot | Collapsed length: ~146cm

CODE: 564FT | 19-22mm dia. x 0.9WT - max. 305cm (10') - threaded spigot | Collapsed length: ~169cm



SWAG POLE



CODE: 564A | 16-19mm dia. x 0.9WT – max. 122cm (4') | Collapsed length: ~74cm



EXTENSION POLE - T NUT - HEAVY DUTY



CODE: 464D | 19-22mm dia. x 1.2WT – max. 228cm (7'6") | Collapsed length: ~126cm

CODE: 464E | 19-22mm dia. x 1.2WT – max. 274cm (9') | Collapsed length: ~146cm

CODE: 364D | 22-25mm dia. x 1.2WT – max. 228cm (7'6") | Collapsed length: ~126cm

CODE: 364E | 22-25mm dia. x 1.2WT – max. 274cm (9') | Collapsed length: ~146cm



EXTENSION POLE - T NUT - HEAVY DUTY SOLID SPIGOT



CODE: 464DMS | 19-22mm dia. x 1.2WT – max. 228cm (7'6") - solid spigot | Collapsed length: ~127cm

CODE: 464EMS | 19-22mm dia. x 1.2WT – max. 274cm (9') - solid spigot | Collapsed length: ~147cm

CODE: 364DMS | 22-25mm dia. x 1.2WT – max. 228cm (7'6") - solid spigot | Collapsed length: ~127cm

CODE: 364EMS | 22-25mm dia. x 1.2WT – max. 274cm (9') - solid spigot | Collapsed length: ~147cm



EXTENSION POLE - WELDED SPIGOT



CODE: 564CWS | 19-22mm dia. x 0.9WT – max. 183cm (6') - solid welded metal spigot | Collapsed length: ~113cm

CODE: 564DWS | 19-22mm dia. x 0.9WT – max. 228cm (7'6") - solid welded metal spigot | Collapsed length: ~129cm

CODE: 564BWS | 19-22mm dia. x 0.9WT – max. 243cm (8') - solid welded metal spigot | Collapsed length: ~136cm

CODE: 564EWS | 19-22mm dia. x 0.9WT – max. 274cm (9') - solid welded metal spigot | Collapsed length: ~149cm

CODE: 564FWS | 19-22mm dia. x 0.9WT – max. 305cm (10') - solid welded metal spigot | Collapsed length: ~172cm



TWO PIECE MARQUEE POLE - STEEL



CODE: 264U | 22mm dia. x 0.9WT – max. 183cm (6')

CODE: 264V | 22mm dia. x 0.9WT – max. 214cm (7')

CODE: 264W | 22mm dia. x 0.9WT – max. 243cm (8')

SPREADER BARS



SPREADER BARS - T NUT - EYE BOTH ENDS



- CODE: 564K | 19-22mm dia. x 0.9WT – max. 122cm (4') - 2 piece | Collapsed length: ~73cm
CODE: 564L | 19-22mm dia. x 0.9WT – max. 152cm (5') - 2 piece | Collapsed length: ~88cm
CODE: 564M | 19-22mm dia. x 0.9WT – max. 183cm (6') - 2 piece | Collapsed length: ~103cm
CODE: 564N | 19-22mm dia. x 0.9WT – max. 213cm (7') - 2 piece | Collapsed length: ~126cm
CODE: 564O | 19-22mm dia. x 0.9WT – max. 243cm (8') - 2 piece | Collapsed length: ~137cm
CODE: 564P | 19-22mm dia. x 0.9WT – max. 274cm (9') - 2 piece | Collapsed length: ~150cm
CODE: 564Q | 19-22mm dia. x 0.9WT – max. 305cm (10') - 2 piece | Collapsed length: ~167cm
CODE: 564S | 22-25mm dia. x 1.2WT – max. 365cm (12') - 3 piece | Collapsed length: ~130cm
CODE: 564X | 22-25mm dia. x 1.2WT – max. 427cm (14') - 3 piece | Collapsed length: ~152cm
CODE: 564Y | 22-25mm dia. x 1.2WT – max. 488cm (16') - 4 piece | Collapsed length: ~133cm
CODE: 564Z | 22-25mm dia. x 1.2WT – max. 548cm (18') - 4 piece | Collapsed length: ~148cm



SPREADER BARS - T NUT - CLIP 1 END



- CODE: 564KC | 19-22mm dia. x 0.9WT – max. 122cm (4') - 2 piece, clip end | Collapsed length: ~76cm
CODE: 564LC | 19-22mm dia. x 0.9WT – max. 152cm (5') - 2 piece, clip end | Collapsed length: ~91cm
CODE: 564MC | 19-22mm dia. x 0.9WT – max. 183cm (6') - 2 piece, clip end | Collapsed length: ~106cm
CODE: 564NC | 19-22mm dia. x 0.9WT – max. 213cm (7') - 2 piece, clip end | Collapsed length: ~129cm
CODE: 564OC | 19-22mm dia. x 0.9WT – max. 243cm (8') - 2 piece, clip end | Collapsed length: ~140cm
CODE: 564PC | 19-22mm dia. x 0.9WT – max. 274cm (9') - 2 piece, clip end | Collapsed length: ~153cm



SPREADER BARS - T NUT - CLIP 2 ENDS



- CODE: 564KC2 | 19-22mm dia. x 0.9WT – max. 122cm (4') - 2 piece, clip 2 ends | Collapsed length: ~74cm
CODE: 564LC2 | 19-22mm dia. x 0.9WT – max. 152cm (5') - 2 piece, clip 2 ends | Collapsed length: ~89cm
CODE: 564MC2 | 19-22mm dia. x 0.9WT – max. 183cm (6') - 2 piece, clip 2 ends | Collapsed length: ~104cm
CODE: 564NC2 | 19-22mm dia. x 0.9WT – max. 213cm (7') - 2 piece, clip 2 ends | Collapsed length: ~127cm
CODE: 564OC2 | 19-22mm dia. x 0.9WT – max. 243cm (8') - 2 piece, clip 2 ends | Collapsed length: ~138cm
CODE: 564PC2 | 19-22mm dia. x 0.9WT – max. 274cm (9') - 2 piece, clip 2 ends | Collapsed length: ~151cm

SPREADER BARS & ROOF RAILS



HEAVY DUTY SQUARE SPREADER BARS



- CODE: SR12 | 22-25mm – max. 365cm (12') - 3 piece | Collapsed length: ~133cm
- CODE: SR15 | 22-25mm – max. 457cm (15') - 3 piece | Collapsed length: ~163cm
- CODE: SR18 | 22-25mm – max. 548cm (18') - 4 piece | Collapsed length: ~155cm
- CODE: SR20 | 22-25mm – max. 608cm (20') - 4 piece | Collapsed length: ~163cm
- CODE: SR24 | 22-25mm – max. 730cm (24') - 5 piece | Collapsed length: ~163cm
- CODE: SR30 | 22-25mm – max. 912cm (30') - 6 piece | Collapsed length: ~163cm
- CODE: SR36 | 22-25mm – max. 1096cm (36') - 8 piece | Collapsed length: ~155cm



ROOF RAILS - T NUT (INCLUDING BRACKET)



- CODE: 564T | 19-22mm dia. x 0.9WT – max. 243cm (8') - eye end | Collapsed length: ~137cm
- CODE: 564V | 19-22mm dia. x 0.9WT – max. 274cm (9') - eye end | Collapsed length: ~150cm
- CODE: 564W | 19-22mm dia. x 0.9WT – max. 305cm (10') - eye end | Collapsed length: ~167cm



ROOF RAILS - T NUT (INCLUDING BRACKET) - CLIP END



- CODE: 564TC | 19-22mm dia. x 0.9WT – max. 243cm (8') - clip end | Collapsed length: ~140cm
- CODE: 564VC | 19-22mm dia. x 0.9WT – max. 274cm (9') - clip end | Collapsed length: ~153cm
- CODE: 564WC | 19-22mm dia. x 0.9WT – max. 305cm (10') - clip end | Collapsed length: ~170cm



ROOF RAILS - T NUT (INCLUDING BRACKET) - SPIGOT END



- CODE: 564TS | 19-22mm dia. x 0.9WT – max. 243cm (8') - spigot end | Collapsed length: ~143cm
- CODE: 564VS | 19-22mm dia. x 0.9WT – max. 274cm (9') - spigot end | Collapsed length: ~156cm
- CODE: 564WS | 19-22mm dia. x 0.9WT – max. 305cm (10') - spigot end | Collapsed length: ~173cm

ALUMINIUM TENT POLES



ALUMINIUM TENT POLES - TWIST LOCK



- CODE: 264S | 22-25mm dia. x 1.2WT – max. 228cm (7'6") - mill finish | Collapsed length: ~131cm
- CODE: 264SW | 22-25mm dia. x 1.2WT – max. 228cm (7'6") - white finish | Collapsed length: ~131cm
- CODE: 264SB | 22-25mm dia. x 1.2WT – max. 228cm (7'6") - black finish | Collapsed length: ~131cm
- CODE: 264T | 22-25mm dia. x 1.2WT – max. 274cm (9') - mill finish | Collapsed length: ~155cm
- CODE: 264TW | 22-25mm dia. x 1.2WT – max. 274cm (9') - white finish | Collapsed length: ~155cm
- CODE: 264TB | 22-25mm dia. x 1.2WT – max. 274cm (9') - black finish | Collapsed length: ~155cm
- CODE: 264TG | 22-25mm dia. x 1.2WT – max. 274cm (9') - grey finish | Collapsed length: ~150cm



ALUMINIUM TENT POLES - TWIST LOCK - CLIP END



- CODE: 264SC | 22-25mm dia. x 1.2WT – max. 228cm (7'6") - clip end, mill finish | Collapsed length: ~129cm
- CODE: 264SWC | 22-25mm dia. x 1.2WT – max. 228cm (7'6") - clip end, white finish | Collapsed length: ~129cm
- CODE: 264SBC | 22-25mm dia. x 1.2WT – max. 228cm (7'6") - clip end, black finish | Collapsed length: ~129cm
- CODE: 264TC | 22-25mm dia. x 1.2WT – max. 274cm (9') - clip end, mill finish | Collapsed length: ~153cm
- CODE: 264TWC | 22-25mm dia. x 1.2WT – max. 274cm (9') - clip end, white finish | Collapsed length: ~153cm
- CODE: 264TBC | 22-25mm dia. x 1.2WT – max. 274cm (9') - clip end, black finish | Collapsed length: ~153cm
- CODE: 264TGC | 22-25mm dia. x 1.2WT – max. 274cm (9') - clip end, grey finish | Collapsed length: ~153cm



ALUMINIUM TENT POLES - CLAMP ADJUSTMENT



- CODE: 264SCL | 22-25mm dia. x 1.2WT – max. 228cm (7'6") - mill finish | Collapsed length: ~129cm
- CODE: 264SWCL | 22-25mm dia. x 1.2WT – max. 228cm (7'6") - white finish | Collapsed length: ~129cm
- CODE: 264SBCL | 22-25mm dia. x 1.2WT – max. 228cm (7'6") - black finish | Collapsed length: ~129cm
- CODE: 264TCL | 22-25mm dia. x 1.2WT – max. 274cm (9') - mill finish | Collapsed length: ~153cm
- CODE: 264TWCL | 22-25mm dia. x 1.2WT – max. 274cm (9') - white finish | Collapsed length: ~153cm
- CODE: 264TBCL | 22-25mm dia. x 1.2WT – max. 274cm (9') - black finish | Collapsed length: ~153cm
- CODE: 264TGCL | 22-25mm dia. x 1.2WT – max. 274cm (9') - grey finish | Collapsed length: ~153cm

ALUMINIUM SPREADER BARS



ALUMINIUM SPREADER BARS - CLAMP ADJUSTMENT



CODE: 264N | 22-25mm spreader bar x 1.2WT – max. 228cm (7'6") - mill finish | Collapsed length: ~130cm

CODE: 264NW | 22-25mm spreader bar x 1.2WT – max. 228cm (7.6") - white finish | Collapsed length: ~130cm

CODE: 264NB | 22-25mm spreader bar x 1.2WT – max. 228cm (7.6") - black finish | Collapsed length: ~130cm

CODE: 264P | 22-25mm spreader bar x 1.2WT – max. 274cm (9') - mill finish | Collapsed length: ~154cm

CODE: 264PB | 22-25mm spreader bar x 1.2WT – max. 274cm (9') - black finish | Collapsed length: ~154cm

CODE: 264PG | 22-25mm spreader bar x 1.2WT – max. 274cm (9') - grey finish | Collapsed length: ~154cm

CODE: 264PW | 22-25mm spreader bar x 1.2WT – max. 274cm (9') - white finish | Collapsed length: ~154cm



ALUMINIUM SPREADER BAR - CLAMP ADJUSTMENT - CLIP 2 ENDS



CODE: 264NC2 | 22-25mm spreader bar x 1.2WT – max. 228cm (7'6") - mill finish

CODE: 264NWC2 | 22-25mm spreader bar x 1.2WT – max. 228cm (7'6") - white finish

CODE: 264NBC2 | 22-25mm spreader bar x 1.2WT – max. 228cm (7'6") - black finish

CODE: 264PC2 | 22-25mm spreader bar x 1.2WT – max. 274cm (9') - mill finish

CODE: 264PWC2 | 22-25mm spreader bar x 1.2WT – max. 274cm (9') - white finish

CODE: 264PBC2 | 22-25mm spreader bar x 1.2WT – max. 274cm (9') - black finish



ALUMINIUM SPREADER BAR BEND SPIGOT - TO MATCH JAYCO VANS



CODE: 264PJS | 22-25mm spreader bar x 1.2WT – max. 274cm (9') - mill finish | Collapsed length: ~156cm



ALUMINIUM SPREADER BAR - SLOTTED BOW END



CODE: 264NSBE | 22-25mm spreader bar x 1.2WT – max. 228cm (7'6") - mill finish

CODE: 264PSBE | 22-25mm spreader bar x 1.2WT – max. 274cm (9') - mill finish

TENT POLE ACCESSORIES



SPIGOT



CODE: 38U | Fits 19mm tube O/D
 CODE: 38W | Fits 22mm tube O/D
 CODE: 38X | Fits 25mm tube O/D



THREADED SPIGOT



CODE: 38UT | Fits 19mm tube O/D
 CODE: 38WT | Fits 22mm tube O/D
 CODE: 38XT | Fits 25mm tube O/D



LONG SPIGOTS



CODE: 38UL
 Fits 19mm tube O/D, 100mm (l)
 CODE: 38WL
 Fits 22mm tube O/D, 100mm (l)
 CODE: 38XL
 Fits 25mm tube O/D, 100mm (l)



SOLID ALUM. SPIGOT



CODE: 38YS | Fits 22mm tube O/D

6MM PIN SPIGOT



CODE: 38WS | Fits 22mm tube O/D



BENT SPIGOT



CODE: 38UB | Fits 19mm tube O/D
 CODE: 38WB | Fits 22mm tube O/D
 CODE: 38XB | Fits 25mm tube O/D



HOOK BENT SPIGOT



CODE: HBS | Fits 22mm tube O/D
 CODE: HBS2 | Fits 25mm tube O/D

JAYCO BENT SPIGOT



CODE: JBS | Fits 22mm tube O/D
 suits Jayco roof rail bracket



S BEND SPIGOT



CODE: SBS1 | Fits 22mm tube O/D
 CODE: SBS2 | Fits 25mm tube O/D

TENT POLE ACCESSORIES



BOW KNUCKLE



CODE: BK19 | Fits 19mm tube O/D
 CODE: BK22 | Fits 22mm tube O/D
 CODE: BK25 | Fits 25mm tube O/D



INTERNAL POLE CAP



CODE: 66Q | 16mm O/D
 CODE: 66R | 19mm O/D
 CODE: 66S | 22mm O/D
 CODE: 66T | 25mm O/D



EXTERNAL POLE CAP



CODE: 66K | 16mm O/D
 CODE: 66L | 19mm O/D
 CODE: 66M | 22mm O/D
 CODE: 66P | 25mm O/D



SQUARE 'C' CLIP SUPPORT CLIP



CODE: 38PSQ | For square ridge poles



PLASTIC SNAP CLIP



CODE: 38PS | Fits/snaps 19mm tube O/D
 CODE: 38PM | Fits/snaps 19/22mm tube O/D
 CODE: 38PL | Fits/snaps 22mm tube O/D
 CODE: 38PO | Fits/snaps 22/25mm tube O/D
 CODE: 38PX | Fits/snaps 25mm tube O/D

JAYCO MOUNTING BRACKET SET



CODE: 38MSJ | Replacement roof rail bracket for Jayco vans



BIRD BEAK & PLATE



CODE: 38E | Fits 22mm/25mm tube O/D



BOW MOUNT



CODE: 39T



WINDOW BRACKET



CODE: 38N

TENT POLE ACCESSORIES

SPLICE CLIP



CODE: 39K | Fits 6mm rope



SPIGOT DOME



CODE: 38V



SPIGOT DOME & SPRING



CODE: 38VSP



POLE CLAMP



CODE: PCL25 | Suits 25mm O/D tube



PLASTIC POLE GROUND PLATE



CODE: 38P

T NUT & THUMBSCREW



CODE: 38Z | Suits all steel poles



QUICK ACTION CLAMP



CODE: PCALC | Fits 25mm O/D tube
CODE: PCALC22 | Fits 22mm O/D tube



SPRING BUTTON CLIP



CODE: 38R



CAMLOK



CODE: CLK | Internal locking mechanism for aluminium pole



BOW ENDS



CODE: BE1 | Fits 19mm tube O/D
CODE: BE2 | Fits 22mm tube O/D
CODE: BE3 | Fits 25mm tube O/D



SQUARE BOW END



CODE: SBE22 | Fits 22mm square tube O/D
CODE: SBE25 | Fits 25mm square tube O/D



SLOTTED BOW END



CODE: BE2S | Fits 22mm tube O/D
CODE: BE3S | Fits 25mm tube O/D

ROOF RAIL BRACKETS



CODE: 38MS | S / steel
CODE: 38MSW | White powder coated S / steel
CODE: 38MSB | Black powder coated S / steel

TORNADO TARPS



- Strong & long lasting
- Swiss patented technology
- Guaranteed lifetime waterproof
- Made from 3 layer cross-laminated XF film
- Tear resistant and ripstop material

- No peeling or cracking
- Puncture resistant
- Extra heavy duty
- High tensile strength
- 100% recyclable
- Engineered stretch and elongation

- 3X superior to traditional woven tarps
- Ultrasonic reinforced aluminium welded eyelets
- UV resistant for 3 years

**3X
superior to
woven
tarps**

**3 year
quality
guarantee**

**3 layers of
XF film**

SILVER TORNADO TARP

- All measurements are finished sizes, so you can use every centimetre you pay for
- 120GSM



CODE: 12AXSUP4X6 | 4ft x 6ft | 1200mm x 1800mm
CODE: 12AXSUP5X7 | 5ft x 7ft | 1500mm x 2100mm
CODE: 12AXSUP6X8 | 6ft x 8ft | 1800mm x 2400mm
CODE: 12AXSUP8X10 | 8ft x 10ft | 2400mm x 3000mm
CODE: 12AXSUP10X12 | 10ft x 12ft | 3000mm x 3600mm
CODE: 12AXSUP12X12 | 12ft x 12ft | 3600mm x 3600mm
CODE: 12AXSUP12X14 | 12ft x 14ft | 3600mm x 4300mm
CODE: 12AXSUP12X16 | 12ft x 16ft | 3600mm x 4800mm
CODE: 12AXSUP16X20 | 16ft x 20ft | 4800mm x 6100mm
CODE: 12AXSUP16X24 | 16ft x 24ft | 4800mm x 7300mm
CODE: 12AXSUP20X26 | 20ft x 26ft | 6100mm x 7900mm
CODE: 12AXSUP20X30 | 20ft x 30ft | 6100mm x 9100mm
CODE: 12AXSUP22X30 | 22ft x 30ft | 6700mm x 9100mm
CODE: 12AXSUP24X30 | 24ft x 30ft | 7300mm x 9100mm

CAMO TORNADO TARP

- All measurements are finished sizes, so you can use every centimetre you pay for
- 150GSM



CODE: 12AXSUP6X8CAMO | 6ft x 8ft | 1800mm x 2400mm
CODE: 12AXSUP10X12CAMO | 10ft x 12ft | 3000mm x 3600mm
CODE: 12AXSUP16X24CAMO | 16ft x 24ft | 4800mm x 7300mm

ROPES & PEGS



GUY ROPES
_____ 73

BULK BUY TENT PEGS
_____ 74

HANG SELL PEGS & ACCESSORIES
_____ 75

PEGGY PEG
_____ 76

ROPE & ACCESSORIES
_____ 78

SHOCK CORD & ACCESSORIES
_____ 79



GUY ROPES



PLASTIC SLIDES



CODE: 38L | Single
- Guy rope kit, 4mm rope with plastic slide



CODE: 38Q | Single
CODE: 38QQ | Double
- Guy rope kit, 6mm rope with plastic slide

POLYMER SLIDES





CODE: 32B | Single
- Guy rope kit, 6mm rope with metal spring and polymer slide





CODE: 32BB | Double
- Guy rope kit, 6mm rope with metal spring and polymer slide

TIMBER SLIDES



CODE: 38J | Single
CODE: 38JJ | Double
- Guy rope kit, 6mm rope with heavy duty wood slide





CODE: 38K | Single
CODE: 38KK | Double
- Guy rope kit, 6mm rope with metal spring and heavy duty wood slide

METAL SLIDES



CODE: 38A | Single
CODE: 38AA | Double
- Guy rope kit, 6mm rope with metal slide



CODE: 38S | Single
CODE: 38SS | Double
- Guy rope kit, 6mm rope with metal slide & spring

BULK BUY TENT PEGS



STEEL TENT PEGS - AUSTRALIAN MADE



- Manufactured from Australian hard galvanised steel
- Approx. 50% harder than mild steel

CODE: 39A | Bulk pack of 400 |
4mm (dia.) x 175mm (l) ($\frac{3}{16}$ " x 7")

CODE: 39B | Bulk pack of 100 |
6.3mm (dia.) x 225mm (l) ($\frac{1}{4}$ " x 9")

CODE: 39C | Bulk pack of 100 |
8mm (dia.) x 300mm (l) ($\frac{5}{16}$ " x 12")

CODE: 39AL | Bulk pack of 100 |
6.3mm (dia.) x 175mm (l) ($\frac{1}{4}$ " x 7")

CODE: 39J | Bulk pack of 100 |
8mm (dia.) x 225mm (l) ($\frac{5}{16}$ " x 9")

CODE: 39D | Bulk pack of 50 |
9.5mm (dia.) x 350mm (l) ($\frac{3}{8}$ " x 14")

STEEL TENT PEGS - IMPORTED



- Zinc plated
- Individually barcoded

CODE: 39Ai | Bulk pack of 100 |
4mm (dia.) x 175mm (l) ($\frac{3}{16}$ " x 7")

CODE: 39Bi | Bulk pack of 100 |
6.3mm (dia.) x 225mm (l) ($\frac{1}{4}$ " x 9")

CODE: 39Di | Bulk pack of 100 |
9.5mm (dia.) x 350mm (l) ($\frac{3}{8}$ " x 14")

CODE: 39ALi | Bulk pack of 100 |
6.3mm (dia.) x 175mm (l) ($\frac{1}{4}$ " x 7")

CODE: 39Ci | Bulk pack of 100 |
8mm (dia.) x 300mm (l) ($\frac{5}{16}$ " x 12")

CODE: 39H | Bulk pack of 50 |
12mm (dia.) x 450mm (l) ($\frac{1}{2}$ " x 18")



PLASTIC SAND PEGS



- Manufactured from Australian polypropylene

CODE: 39E
Bulk pack of 100 | 220mm (l) (9")

CODE: 39F
Bulk pack of 100 | 300mm (l) (12")

CODE: 39G
Bulk pack of 50 | 500mm (l) (19")



STEEL TENT PEGS - HANG SELL



- CODE: 39AP | Bag of 10 | 4mm d. x 175mm (l) ($\frac{3}{16}$ " x 7")
- CODE: 39ALP | Bag of 10 | 6.3mm d. x 175mm (l) ($\frac{1}{4}$ " x 7")
- CODE: 39BP | Bag of 10 | 6.3mm d. x 225mm (l) ($\frac{1}{4}$ " x 9")
- CODE: 39BLP | Bag of 10 | 6.3mm d. x 300mm (l) ($\frac{1}{4}$ " x 12")
- CODE: 39JP | Bag of 6 | 8mm d. x 225mm (l) ($\frac{5}{16}$ " x 9")
- CODE: 39CP | Bag of 6 | 8mm d. x 300mm (l) ($\frac{5}{16}$ " x 12")
- CODE: 39DP | Bag of 4 | 9.5mm d. x 350mm (l) ($\frac{3}{8}$ " x 14")



PLASTIC TENT PEGS - HANG SELL



- CODE: 39EP | Hang sell bag of 6 | 220mm (l) (9")
- CODE: 39FP | Hang sell bag of 4 | 30mm (l) (12")
- CODE: 39GP | Hang sell bag of 3 | 500mm (l) (19")



TENT PEG PULLER



- CODE: TPP1
- One piece design for easy removal of tent pegs
- Dimensions: 800mm (l)

TENT PEG BAG



- CODE: TPB
- Canvas bag for pegs & guy ropes
- Dimensions: 450mm (l) x 100mm (w) x 100mm (h)

TENT POLE BAG



- CODE: LPB
- Canvas bag to suit tent poles
- Dimensions: 1.65m (l) x 80mm (w) x 160mm (h)



PEGGY PEG TENT PEGS

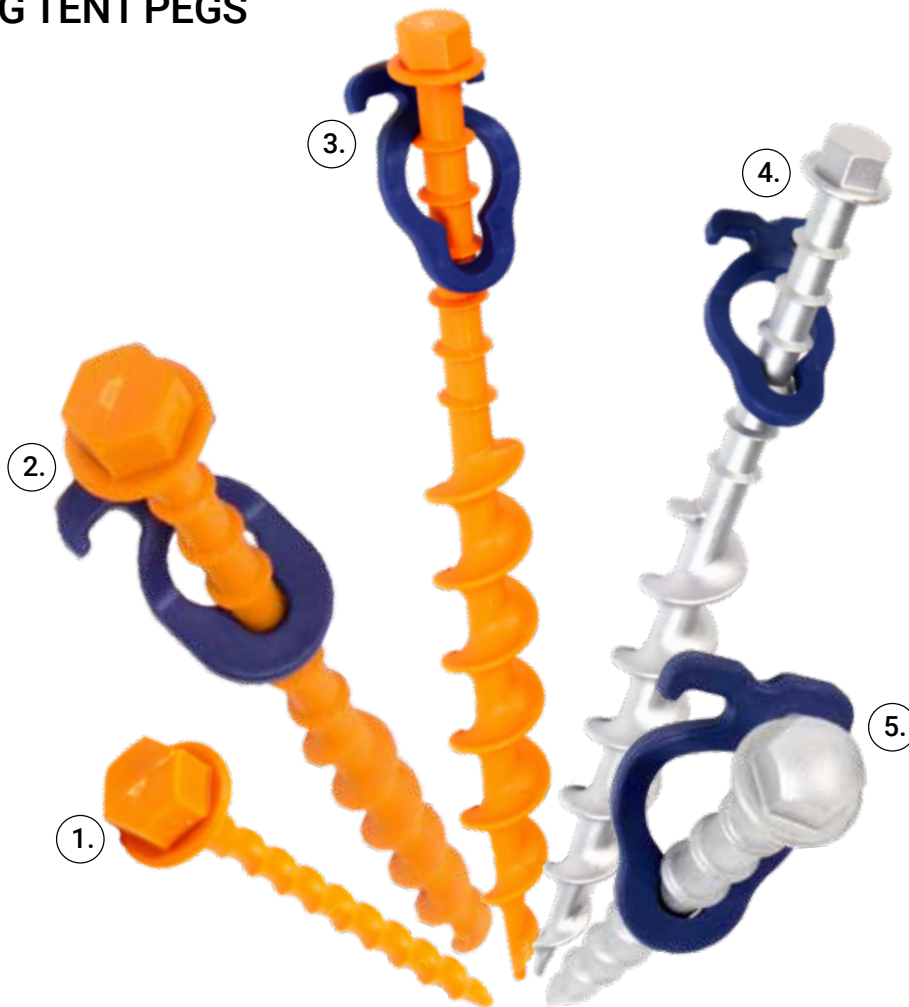

- | | | | | |
|--|--|--|--|--|
| <p>1. CODE: SUPP05
 - Use for ground matting and sunshades
 - Pack of 12
 Dimensions: 120mm (l)</p> | <p>2. CODE: SUPP02
 - For tarps, tents, awnings etc.
 - Pack of 12
 Dimensions: 200mm (l)</p> | <p>3. CODE: SUPP12
 - Great for sandy areas and soft ground
 - Pack of 2
 Dimensions: 310mm (l)</p> | <p>4. CODE: SUPP13
 - Best for gazebos, awnings, marquees
 - Pack of 2
 Dimensions: 310mm (l)</p> | <p>5. CODE: SUHP61
 - Great for stony, rocky ground
 - Pack of 4
 Dimensions: 150mm (l)</p> |
|--|--|--|--|--|

HARDCORE COMBO TOOL



- CODE: SUHP68**
- Hardcore aluminium version of the drill adaptor and hand driver
 - For drilling pegs where the torque is likely to be high
 - Recommended for drilling pegs, not screwing in by hand

TIE STRAP



- CODE: SUPP25**
- Guy rope & heavy duty spring act as shock absorbers; blue rope clips for a secure connection
 - Fast-action buckle ensures no loose ends
 - Adjustable length; 1.5m - 3.0m

FIX & GO ANCHOR PLATE



- CODE: SUPP16**
- Anchor plate for securing the awning and ensuring stability
 - Lock awning leg into position and secure with Peggy Peg screw-in pegs
 - For almost all ground types & with most awning and tent pole styles



STARTER KIT



CODE: SUPP03

- Complete set-up starter pack
- Presented in a durable canvas bag, with additional space for storing extra pegs and/or other Peggy Peg accessories

- Contains:
- 30 x standard pegs
 - 20 x small pegs
 - 1 x combo tool
 - 2 x drill bits

Pack dimensions:
80mm (d) x 360mm (w) x 130mm (h)

270° AWNING STARTER KIT



CODE: SUPP63

- The essential set up kit for the 270° Awning in all soil types
- Comes in a durable carry bag that is spacious enough to include other Peggy Peg products bought separately

Pack dimensions:
250mm (d) x 850mm (w) x 550mm (h)

Weight: 1.4kg

- Contains:
- 6 x L Hooks
 - 3 x N Hooks
 - 3 x U-connectors
 - 3 x T-connectors
 - 1 x Combi alloy tool
 - 3 x Screw-in pegs N 20cm
 - 3 x Hit-in screw out Hardcore pegs 15cm
 - 3 x Screw-in pegs L 32cm
 - 3 x Crocodiles Peggy

ROPE & ACCESSORIES



ROPE COIL



ROPE REEL

POLYPROPYLENE ROPE

CODE: 34AC | 4mm coil | 250m
 CODE: 34BC | 6mm coil | 250m
 CODE: 34DC | 10mm coil | 250m
 CODE: 34EC | 12mm coil | 250m

SILVER ROPE

CODE: 34HR | 4mm reel | 300m
 CODE: 34FC | 6mm coil | 250m
 CODE: 34FR | 6mm reel | 300m
 CODE: 34GC | 8mm coil | 250m
 CODE: 34GR | 8mm reel | 200m

CODE: 34IC | 10mm coil | 250m
 CODE: 34IR | 10mm reel | 125m
 CODE: 34JC | 12mm coil | 250m
 CODE: 34JR | 12mm reel | 125m

VENETIAN BLIND CORD

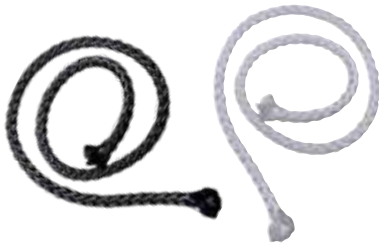

CODE: VBB | Black | 3mm (dia.) x 500m (l)
 CODE: VBW | White | 3mm (dia.) x 500m (l)

MINI COILS



CODE: MC1 | 4mm (dia.) x 20m (l)
 CODE: MC2 | 6mm (dia.) x 20m (l)



TRACE SPRINGS

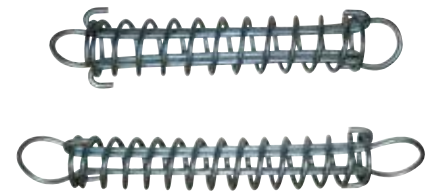

CODE: 38C | 150mm / 6"
 CODE: 38D | 200mm / 8"



POLYMER SLIDE



CODE: 32C
 - To suit 4mm, 6mm & 8mm rope



TIMBER SLIDE



CODE: 38G
 Dimensions:
 30mm (dia.) x 140mm (l)



COMBO SLIDE



CODE: 38B
 - Plastic slide to suit 4mm & 6mm rope



WIRE ROPE SLIDE



CODE: 38H
 - To suit 4mm, 6mm & 8mm rope

SHOCK CORD & ACCESSORIES



BLACK SHOCK CORD

- CODE: SC02 | 2mm (dia.) x 100m (l)
- CODE: SC03 | 3mm (dia.) x 100m (l)
- CODE: SC04 | 4mm (dia.) x 100m (l)
- CODE: SC05 | 5mm (dia.) x 100m (l)
- CODE: SC06 | 6mm (dia.) x 100m (l)
- CODE: SC07 | 7mm (dia.) x 50m (l)
- CODE: SC08 | 8mm (dia.) x 50m (l)
- CODE: SC010 | 10mm (dia.) x 50m (l)



SHOCK CORD LOOP



- CODE: LP1 | Loop 70mm; Cord 150mm
- CODE: LP2 | Loop 80mm; Cord 170mm
- CODE: LP3 | Loop 90mm; Cord 190mm
- CODE: LP4 | Loop 100mm; Cord 209mm

FASTENER HOOK



- CODE: 66A | 6mm
- CODE: 66B | 8mm

SHOCK CORD HOOK



- CODE: KB2 | Plastic
- CODE: KB3 | Metal

SHOCK CORD KNOB



- CODE: KB1



HOLD TIGHT TARP GRIPPER



- CODE: SH038I | Individual
- CODE: SH038P | Pack of 4
- CODE: SH038C | Display carton holds 15 x packs of 4

BUNGEE CORD WITH TOGGLE BALL



- CODE: ELO2 | Bulk
- CODE: ELO2P | Pack of 2, hang sell
- For tying down tarpaulins and/or privacy screens

ELASTIC SHOCK CORD WITH HOOK



- CODE: ESCH | Pack of 2, hang sell
- CODE: ESCHB | Bulk
- Tension absorber with plastic coated hook

MAINTENANCE & REPAIR

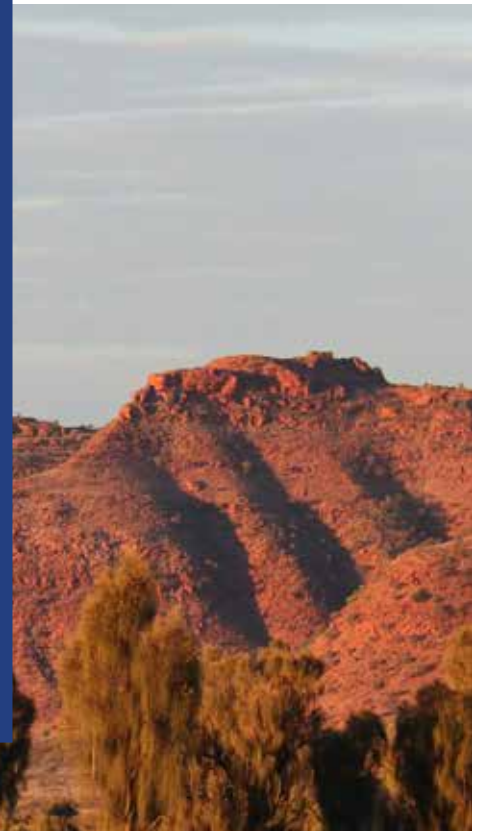

WEBBING
_____ 81

HOOK & LOOP TAPE
_____ 81

CANVAS ACCESSORIES
_____ 82

STIMEX FABRIC TREATMENT
_____ 83

TEAR AID
_____ 84

FIX N ZIP
_____ 85

WEBBING | HOOK & LOOP TAPE



POLY WEBBING



CODE: PW20 | 20mm (w) x 50m (l)
 CODE: PW25 | 25mm (w) x 50m (l)
 CODE: PW38 | 38mm (w) x 50m (l)
 CODE: PW50 | 50mm (w) x 50m (l)

SEAT BELT WEBBING



CODE: SBW25 | 25mm (w) x 100m (l)
 CODE: SBW50 | 50mm (w) x 100m (l)

BACK TO BACK HOOK & LOOP TAPE



CODE: BB25 | Black
 25mm (w) x 12.5m (l)
 CODE: BB50 | Black
 50mm (w) x 12.5m (l)

HOOK & LOOP TAPE



SELF ADHESIVE - 25MM & 50MM

CODE: HSA25BL | Black hook | 25mm (w) x 25m (l)
 CODE: LSA25BL | Black loop | 25mm (w) x 25m (l)
 CODE: HSA25WH | White hook | 25mm (w) x 25m (l)
 CODE: LSA25WH | White loop | 25mm (w) x 25m (l)

CODE: HSA50BL | Black hook | 50mm (w) x 25m (l)
 CODE: LSA50BL | Black loop | 50mm (w) x 25m (l)
 CODE: HSA50WH | White hook | 50mm (w) x 25m (l)
 CODE: LSA50WH | White loop | 50mm (w) x 25m (l)

SEW ON - 25MM

CODE: HSW25BL | Black hook | 25mm (w) x 25m (l)
 CODE: LSW25BL | Black loop | 25mm (w) x 25m (l)
 CODE: HSW25WH | White hook | 25mm (w) x 25m (l)
 CODE: LSW25WH | White loop | 25mm (w) x 25m (l)

CODE: HSW25BE | Beige hook | 25mm (w) x 25m (l)
 CODE: LSW25BE | Beige loop | 25mm (w) x 25m (l)
 CODE: HSW25GR | Grey hook | 25mm (w) x 25m (l)
 CODE: LSW25GR | Grey loop | 25mm (w) x 25m (l)

SEW ON - 50MM

CODE: HSW50BL | Black hook | 50mm (w) x 25m (l)
 CODE: LSW50BL | Black loop | 50mm (w) x 25m (l)
 CODE: HSW50WH | White hook | 50mm (w) x 25m (l)
 CODE: LSW50WH | White loop | 50mm (w) x 25m (l)

CODE: HSW50BE | Beige hook | 50mm (w) x 25m (l)
 CODE: LSW50BE | Beige loop | 50mm (w) x 25m (l)
 CODE: HSW50GR | Grey hook | 50mm (w) x 25m (l)
 CODE: LSW50GR | Grey loop | 50mm (w) x 25m (l)



SIDE RELEASE BUCKLES

CODE: SRB19 | 19mm
 CODE: SRB25 | 25mm
 CODE: SRB38 | 38mm
 CODE: SRB50 | 50mm



TRIGLIDES



CODE: 66C | 19mm
 CODE: 66D | 25mm
 CODE: 66E | 38mm
 CODE: 66F | 50mm

LADDER LOCK



CODE: 66G | 19mm
 CODE: 66H | 25mm

D RINGS



CODE: DR1
 3.2mm (dia.) x 25mm (w) x 21mm (d)
 CODE: DR2
 5mm (dia.) x 25mm (w) x 23mm (d)
 CODE: DR3
 6mm (dia.) x 25mm (w) x 38mm (d)
 CODE: DR4
 6mm (dia.) x 25mm (w) x 46mm (d)

VERTICAL T-TOGGLE WITH METAL FLIPPER



CODE: 66NW | White
 CODE: 66NB | Black
 CODE: 66NWD | White, double
 CODE: 66NBD | Black, double

HORIZONTAL T-TOGGLE WITH METAL FLIPPER



CODE: 66OW | White
 CODE: 66OB | Black
 CODE: 66OWD | White, double
 CODE: 66OBD | Black, double

CANVAS TO CANVAS T-TOGGLE WITH METAL FLIPPER



CODE: 66IW | White
 CODE: 66IB | Black
 CODE: 66IWD | White, double
 CODE: 66IBD | Black, double

STIMEX FABRIC TREATMENT



WATERPROOFER



CODE: STWP | Spray can, 500mL

CODE: STWB | Liquid, 500mL

- High concentrate textile coating for fabric treatment
- Permanently elastic and breathable
- Can be applied to moist fabric
- Liquid dilutes to 4L
- Spray covers 20m²

OUTDOOR SPRAY



CODE: STOS | Spray can, 500mL

- For use on outer of outdoor clothing made from waterproof, windproof and breathable fabrics
- Also suited for use on other outdoor clothing, e.g. fleece and shoes
- Silicone free for ventilation

LEAK REPAIR



CODE: STPR | Liquid, 80mL

- Leak repair for punctures and holes in PVC and vinyl
- Can be used underwater
- Includes applicator brush

CAMPER CLEANER



CODE: STCC | Liquid, 500mL

- For use in caravans, campers, boats, cars and interiors, barbecues, garden furniture
- Removes algae, tar, insects, dirt
- Environmentally friendly

TENT CLEANER



CODE: STTC | Liquid, 500mL

- Detergent for tents, garden parasols, sun shades, awnings, boat sails, chair cushions
- Removes seasonal soiling
- Environmentally friendly
- Treats approx. 50m² of material (e.g. canvas, cotton, dralon, acrylic, nylon, polyester, PVC coatings)

SEAM SEALER



CODE: STSS | Liquid, 85mL

- Waterproofing compound for use on inside of seams
- Includes applicator brush

TEAR AID



RETAIL PACK

- Includes 1 x 75mm (w) x 300mm (l) piece
- Plus additional small patches



CODE: TAO | TYPE A Gold



CODE: TAV | TYPE B Green



CODE: TAB | TYPE B Blue



CODE: TAY | TYPE B Yellow

WORKSHOP PACK

CODE: TAO2 | TYPE A Gold

CODE: TAV2 | TYPE B Green

- Includes 1 x 75mm (w) x 1500mm (l) roll





FIX N ZIP™



CODE: 3PNZ | FixnZip™ three-pack (shown in display box)



CODE: SNZ | Small: Zipper Sizes 1-4

Examples: Pants, skirts, fine garments, cushions, clutch handbags



CODE: MNZ | Medium: Zipper Sizes 5-7

Examples: Jackets, sleeping bags, tents, purses, duffel bags, golf bags



CODE: LNZ | Large: Zipper Sizes 8-10

Examples: Wetsuits, boat covers, canvas tents, heavy duty clothing, Jeep windows

CODE: SNZ | Single, small FixnZip™

CODE: MNZ | Single, medium FixnZip™

CODE: LNZ | Single, large FixnZip™

CODE: 3PNZ | FixnZip™ three-pack: contains 1 x small, 1 x medium, 1 x large

- High quality, easy to use zipper slider replacements
- Replace stuck, corroded, worn or broken zipper sliders in seconds
- Available in three sizes to suit varying types of zippers, regardless of brand
- No tools or sewing required
- Manufactured from nickel plated zinc

How to use:

- Secure the fastener to the zipper teeth and zip away, it's that easy!

Material:

Nickel Plated Zinc

WATCH THE
'HOW TO' VIDEO:



BEDDING



AIR BEDS
_____ 87

SELF INFLATING MATS
_____ 87

TREKWAY
_____ 87

SLEEPING BAGS
_____ 88

AIR BEDS | SELF INFLATING MATS



VELOUR AIR BEDS



- CODE: AIRB1** | Single | 185cm (l) x 76cm (w) x 22cm (d)
CODE: AIRB2 | Twin | 188cm (l) x 99cm (w) x 22cm (d)
CODE: AIRB3 | Double | 191cm (l) x 137cm (w) x 22cm (d)
CODE: AIRB4 | Queen | 203cm (l) x 152cm (w) x 22cm (d)
- SID Valve (Smart Inflation/Deflation)
 - Coil beam construction
 - PVC base
 - Velour top

DELUXE OFF ROAD 4WD MAT



- CODE: AB501** | Single | 195cm (l) x 60cm (w) x 6cm (d)
CODE: AB502 | Mega | 195cm (l) x 80cm (w) x 6cm (d)
CODE: AB503 | Mega + | 195cm (l) x 100cm (w) x 6cm (d)
CODE: AB506 | Twin | 195cm (l) x 120cm (w) x 6cm (d)
CODE: AB504 | Double | 195cm (l) x 130cm (w) x 6cm (d)
CODE: AB505 | Queen | 195cm (l) x 150cm (w) x 6cm (d)
- Self inflating with non-slip base
 - Large top seam valves for superior inflation & deflation
 - Two year warranty
 - Includes carry bag & compression straps
 - Sizes listed are as inflated

HIKER SELF INFLATING MAT



- CODE: AB507**
- Single person self inflating mattress, perfect for hikers
 - Includes carry bag
 - R Value: 3.2
 - Weight: 880g

Dimensions:
 185cm (l) x 53cm (w) x 35cm (d)

TREKWAY SELF INFLATING MAT - 10CM



- CODE: AB508** | Single | 195cm (l) x 80cm (w) x 10cm (d)
CODE: AB509 | Double | 195cm (l) x 140cm (w) x 10cm (d)
- Extra comfort self inflating mattress (10cm thickness)
 - Made from high quality thermoplastic polyurethane
 - Includes carry bag
 - Top & side walls: 30D stretch-knitted fabric-coated TPU
 - Base: 210D oxford with TPU coating
 - R value: 8.5

SLEEPING BAGS



EVADE 15

CODE: SUP68099

- Two designs available
- 'S' shape quilting
- Ideal temperature range: 7° ~ 11°
- Shell fabric: 170T polyester
- Lining fabric: 170T polyester
- Padding: 170g/m² hollow fibre



EVADE 10

CODE: SUP68100

- Elastic straps
- Pillow included
- Circular shape quilting
- Ideal temperature range: 3° ~ 8°
- Shell fabric: 190T polyester
- Lining fabric: 190T polyester
- Padding: 220g/m² hollow fibre



EVADE 5

CODE: SUP68101

- Two designs available
- Pillow included; one way zipper
- Circular shape quilting
- Elastic straps
- Ideal temperature range: 4° ~ 8°
- Shell fabric: 190T polyester
- Lining fabric: 190T polyester
- Padding: 300g/m² hollow fibre



SLEEPING BAGS



HIBERHIDE 10

CODE: SUP68102

- Two designs available
- Oblique line quilting on front; straight quilting on back
- Semi-circular hood for head support and insulation
- One way zipper
- Ideal temperature range: 6° ~ 10°
- Shell fabric: 170T polyester
- Lining fabric: 170T polyester
- Padding: 170g/m² hollow fibre

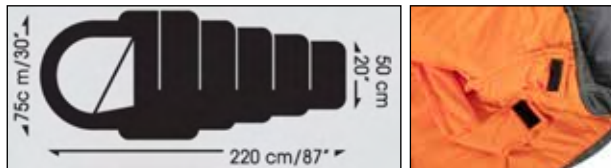

HIBERHIDE 5

CODE: SUP68103

- Oblique line quilting on front; straight quilting on back
- Semi-circular hood with drawstring for head support and insulation
- Insulating draft protection along two way zipper
- Anti-cold shoulder flap
- Ideal temperature range: 3° ~ 8°
- Shell fabric: 210T polyester
- Lining fabric: 190T polyester
- Padding: 250g/m² hollow fibre



HIBERHIDE 0

CODE: SUP68104

- Oblique line quilting on front; straight quilting on back
- Semi-circular hood with drawstring for head support and insulation
- Insulating draft protection along two way zipper
- Anti-cold shoulder flap
- Ideal temperature range: -4° ~ -1°
- Shell fabric: 210T polyester, rib-stop
- Lining fabric: 190T polyester pongee
- Padding: 150g/m² double layer, hollow fibre



FURNITURE



ACTION CHAIRS	FOLDING STOOLS & CHAIRETTE
_____ 91	_____ 94
DIRECTORS CHAIRS	TABLES
_____ 92	_____ 95
FOLDING CHAIRS	
_____ 92	
WANDERLITE	
_____ 93	

ACTION CHAIRS



KIDS ACTION CHAIR



CODE: 23KS

- Children's sized action chair, available in green and pink
 - Made from durable 600D PVC fabric
 - Features mesh cup holder
 - Includes carry bag
 - Each carton contains 3 x pink and 3 x green chairs
- Weight Rating: 80kg / Product Weight: 2.0kg

Dimensions:

- Back: 60.5cm / Seat: 31cm (h) x 33.5cm (d) x 41cm (w)

Stored Dimensions:

- 14cm (d) x 16cm (w) x 65cm (h)

CAMP QUAD CHAIR



CODE: 23L

- Simple, practical, comfortable
 - Made from durable 600D PVC fabric with 19mm powder coated steel frame
 - Features mesh cup holder, includes carry bag
- Weight Rating: 100kg / Product Weight: 2.2kg

Dimensions:

- Back: 91cm / Seat: 44cm (h) x 50cm (d) x 45cm (w)

Stored Dimensions:

- 20cm (d) x 20cm (w) x 108cm (h)

KING SIZE ACTION CHAIR



CODE: 23K

- High quality king size action chair
 - Made from durable 600D PVC fabric with 19mm powder coated steel frame
 - Features fabric cup holder, side pocket and quilted design, includes carry bag
- Weight Rating: 130kg / Product Weight: 3.5kg

Dimensions:

- Back: 111cm / Seat: 50cm (h) x 53cm (d) x 59cm (w)

Stored Dimensions:

- 23cm (d) x 23cm (w) x 104cm (h)

SUPER KING SIZE ACTION CHAIR



CODE: 23P

- Made from 600D PVC fabric with 22mm black powder coated steel frame
 - Features insulated cup holder & cooler, bottle opener, padded headrest, adjustable armrests and mesh side pocket, includes carry bag
- Weight rating: 150kg / Product Weight: 6.3kg

Dimensions:

- Back: 109cm / Seat: 46cm (h) x 51cm (d) x 62cm (w)

Stored Dimensions:

- 17cm (d) x 50cm (w) x 80cm (h)



ALUMINIUM DIRECTORS CHAIR



CODE: 23JA

- Lightweight frame, 600D PVC cover
- Features: foldable side table, cup holder, anti-tip leg design, single piece cover, padded arm rests
- Weight rating: 100kg
- Product Weight: 2.9kg

Dimensions:

- Back: 79cm
- Seat: 44cm (h) x 36cm (d) x 50cm (w)
- Stored Dimensions:
- 10cm (d) x 50cm (w) x 80cm (h)

FOLDING DIRECTORS CHAIR



CODE: 23H

- Back rest detaches and folds away
- Features: front & back anti-tip leg design, foldable side table, cup holder, carry bag
- Weight Rating: 130kg
- Product Weight: 6.5kg

Dimensions:

- Back: 93cm
- Seat: 46cm (h) x 40cm (d) x 57cm (w)
- Stored Dimensions:
- 13cm (d) x 70cm (w) x 47cm (h)

STEEL DIRECTORS CHAIR



CODE: 23JS

- Black powder coated steel frame
- Made from 600D PVC fabric
- Features: front and back anti-tip leg design, foldable side table, cup holder, single piece cover
- Weight rating: 120kg
- Product Weight: 6.3kg

Dimensions:

- Back: 85cm
- Seat: 43cm (h) x 42cm (d) x 47cm (w)
- Stored Dimensions:
- 20cm (d) x 30cm (w) x 85cm (h)

FIVE POSITION HARD ARM CHAIR



CODE: 23S

- Back rest tilts to 5 different positions
- Made from 600D PVC fabric with 22mm black powder coated steel frame
- Features: anti-tip leg design, cup holder, wine glass holder
- Weight Rating: 130kg / Product Weight: 6.0kg

Dimensions:

- Back: 105cm / Seat: 46.5cm (h) x 47cm (d) x 49cm (w)
- Stored Dimensions:
- 13cm (d) x 60cm (w) x 98cm (h)

BEACH CHAIR



CODE: 23B

- Made from hard-wearing 600D PVC fabric with 22mm steel powder coated frame
- Features: foldable design, built-in towel rail (on back, not seen)
- Weight Rating: 100kg

Dimensions:

- Folded: 10cm (d) x 45cm (w) x 82cm (h)
- Unfolded: 60cm (d) x 45cm (w) x 60cm (h)



WANDERLITE™ ULTRA HIKER CHAIR



CODE: 23G

- Ultralight collapsible chair
- Made from 600D Oxford cloth with high strength aluminium alloy frame
- Features: easy assembly, foldable legs, scientifically structured design
- Weight Rating: 150kg / Product Weight: 0.92kg

Dimensions:

- 51cm (d) x 57cm (w) x 65cm (h)
- Fits into carry bag - 11cm (d) x 15cm (w) x 36cm (l)

WANDERLITE™ MIGHTY HIKER CHAIR



CODE: 23F

- Medium lightweight collapsible chair
- Made from 600D Oxford cloth with high strength aluminium alloy frame
- Features: mesh pocket, bottle holder, easy assembly, foldable legs, scientifically structured design
- Weight Rating: 120kg / Product Weight: 1.39kg

Dimensions:

- 64cm (d) x 65cm (w) x 79 cm (h)
- Fits into carry bag - 11cm (d) x 47cm (l)

WANDERLITE™ VOYAGER CHAIR



CODE: 23M

- Large lightweight collapsible chair
- Made from 600D Oxford cloth with high strength aluminium alloy frame
- Features: easy assembly, foldable legs, scientifically structured design, padded headrest
- Weight Rating: 120kg / Product Weight: 1.45kg

Dimensions:

- 80cm (d) x 53cm (w) x 97cm (h)
- Fits into carry bag - 10cm (d) x 47cm (l)

WANDERLITE™ NOMAD TABLE



CODE: 23W

- Super-light slat table
- High strength aluminium alloy frame with black plastic clip-on slats
- Features: easy assembly, flat-pack legs and slats, scientifically structured design
- Includes carry bag
- Weight Capacity: 15kg / Product Weight: 1.2kg

Dimensions:

- 40cm (d) x 56cm (w) x 40cm (h)



SMALL TRI LEG STOOL



CODE: 21E

- 19mm steel legs
 - 600D PVC fabric cover
 - Weight rating: 100kg / Product Weight: 0.9kg
- Dimensions:
- Seat: 30cm (d) x 30cm (w)
 - Stool height: 50cm
- Stored Dimensions:
- 7cm (d) x 8cm (w) x 58cm (h)

LARGE TRI LEG STOOL



CODE: 21F

- 19mm steel legs
 - 600D PVC fabric cover
 - Weight rating: 100kg / Product Weight: 1.4kg
- Dimensions:
- Seat: 33cm (d) x 33cm (w)
 - Stool height: 65cm
- Stored Dimensions:
- 7cm (d) x 8cm (w) x 77cm (h)



SMALL HOOP LEG STOOL



CODE: 21B

- Galvanised 19mm steel frame
 - Canvas cover {colours vary}
- Dimensions:
- Stool height - 41cm
 - Seat area - 22cm (d) x 31cm (w)



LARGE HOOP LEG STOOL



CODE: 21C

- Galvanised 19mm steel frame
 - Canvas cover {colours vary}
- Dimensions:
- Stool height - 45cm
 - Seat area - 28cm (d) x 34cm (w)



CHAIRETTE



CODE: 23D

- Galvanised 19mm steel frame
 - Canvas cover {colours vary}
- Dimensions:
- Stool height - 40cm
 - Seat area - 32cm (d) x 33cm (w)

TABLES



UTILITY TABLE



CODE: 31K

- Portable & lightweight
- Easy to carry, quick to set up
- Aluminium frame with MDF top
- Folds flat to save space

Dimensions:

38cm (d) x 53cm (w) x 64cm (h)
Product Weight: 2.5kg

PERSONAL TABLE



CODE: 31M

- Blow-moulded for superior strength
- Folds flat for the space efficiency
- Four adjustable height positions
- Steel legs, 19mm dia.

Dimensions:

50cm (d) x 77cm (w)
Heights: 12cm, 50cm, 63.5cm, 74cm
Product Weight: 5.0kg

LIGHTWEIGHT TABLE



CODE: 31G

- Classic camping table, easy to carry and assemble
- Folding legs for compact storage
- Aluminium frame with MDF top

Dimensions:

60cm (d) x 80cm (w) x 70cm (h)
Product Weight: 3.6kg

FOLD IN HALF TABLE



CODE: 31F

- Sturdy fold in half table
- Aluminium frame with MDF top
- Includes carry bag
- Features: removable mesh shelf, height adjustable legs up to 70cm

Dimensions:

120cm (w) x 60cm (d) x 70cm (h)
Product Weight: 5.3kg

SMALL FOLD IN HALF TABLE



CODE: 31S

- Lightweight fold in half table
- Black aluminium frame with woodgrain style MDF top
- Small & compact for efficient use of space

Dimensions:

39.5cm (d) x 60cm (w) x 40cm (h)
Product Weight: 2.0kg

SLAT TABLE



CODE: 31D

- Lightweight aluminium slat table
- Folds into compact carry bag

Dimensions:

70cm (d) x 70cm (w) x 70cm (h)
Product Weight: 3.0kg

COOKWARE



DUTCH OVENS	97	TOASTERS	99
TRIPODS	97	ZEBRA STAINLESS STEELWARE	100
FRYPANS	98	WATER CONTAINERS	104
SAUCEPANS	99	FUEL CONTAINERS & ACCESSORIES	105
JAFFLE IRONS	99		

DUTCH OVENS | TRIPODS



DUTCH OVENS - PRE SEASONED



CODE: D025 | 2.5 quart
CODE: D045 | 4.5 quart

CODE: D090 | 9 quart
CODE: D0100 | 10 quart

CODE: D0120 | 12 quart
CODE: D0160 | 16 quart

DUTCH OVEN LID LIFTER



CODE: DOL1
Dimensions: 425mm (l)

LARGE TRIPOD



CODE: TP3 |
10mm (dia.) x 900mm (h)
CODE: TP4 |
10mm (dia.) x 1200mm (h)
- Solid steel
- Includes carry bag

SMALL TRIPOD



CODE: TP5
- Multipurpose; can be used with
frypans, skillets, ovens, woks and
saucepans
- Folds flat for easy storage
- Includes carry bag

CAST IRON FRYPANS

GRIDDLE PANS

RECTANGULAR



CODE: FPFH1

- Pre-seasoned with a wooden handle and griddle base

Dimensions:
210mm (w) x 350mm (d)

ROUND



CODE: FPFH2

- Pre-seasoned with a wooden handle and griddle base

Dimensions:
240mm dia.

SQUARE



CODE: FPFH3

- Pre-seasoned with a wooden handle and griddle base

Dimensions:
240mm (w) x 240mm (d)

ROUND



CODE: FP9 | Round | 220mm dia.

CODE: FP11 | Round | 280mm dia.

CODE: FP12 | Round | 300mm dia.

- Pre-seasoned with wooden screw-in handle

SQUARE



CODE: FP10

- Pre-seasoned with wooden screw-in handle
- Square, griddle base

Dimensions:
250mm (w) x 250mm (d)



SMALL SAUCEPAN



CODE: SP2

- Pre-seasoned with wooden handle

Volume:

- Two quart

MEDIUM SAUCEPAN



CODE: SP3

- Pre-seasoned with wooden handle

Volume:

- Three quart

SINGLE JAFFLE IRON



CODE: JISL

- Pre-seasoned with metal clasp and wooden handle

Dimensions:

130mm (w) x 140mm (d)

DOUBLE JAFFLE IRON



CODE: JIDL

- Pre-seasoned with metal clasp and wooden handle

Dimensions:

275mm (w) x 140mm (d)

SINGLE SLICE TOASTER



CODE: MBSTT

- Single slice box toaster

Dimensions:

110mm (d) x 165mm (w) x 30mm (h)

FOUR SLICE TOASTER

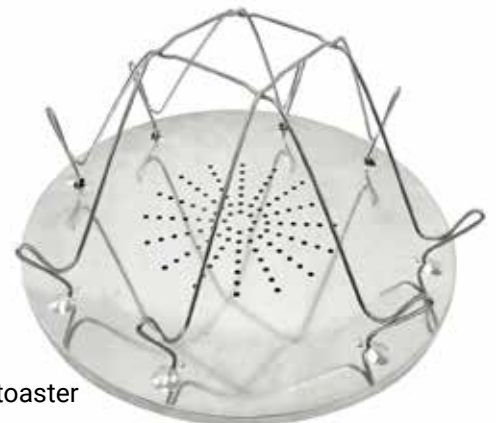

CODE: M4SLT

- Four slice box toaster

Dimensions:

200mm (dia.) x 15mm (h)
Assembled height - 220mm



MUG



CODE: SUP110007 | 7cm dia. | 250mL
CODE: SUP110008 | 8cm dia. | 400mL
CODE: SUP110009 | 9cm dia. | 500mL
CODE: SUP110010 | 10cm dia. | 750mL

MUG WITH LID



CODE: SUP110108 | 8cm dia. | 400mL
CODE: SUP110109 | 9cm dia. | 500mL
CODE: SUP110110 | 10cm dia. | 750mL

PLATE



CODE: SUP120020 | 20cm dia.
CODE: SUP120023 | 23cm dia.

BOWL



CODE: SUP111014 | 14cm dia. | 800mL
CODE: SUP111018 | 18cm dia. | 1.6L

ZEBRA STAINLESS STEELWARE



LOOP HANDLE POT

CODE: SUP151612 | 12cm dia. | 1.4L

CODE: SUP151614 | 14cm dia. | 2.0L

CODE: SUP151616 | 16cm dia. | 3.0L



BILLY



CODE: SUP113114

- Billy style tea pot with seamless interior, fitted lid, folding handle and slotted spout
- 14cm diameter | 2.0L capacity

WHISTLING KETTLE



CODE: SUP113524 | 3.5L capacity

ZEBRA STAINLESS STEELWARE

CAMPING SET

CODE: SUP184211

- Three piece camping set with carry bag
- Includes two pots (one with folding handle) and frying pan with folding handle

Dimensions:

Pot with handle - 14cm dia., 1.2L capacity

Pot with folding handle - 16cm dia., 1.7L capacity

Frying pan with folding handle - 16cm dia., 700ml capacity



STOCK POT

CODE: SUP171228

- For use on all stoves
- 28cm diameter
- 17.2L capacity





LUNCH BOX



CODE: SUP152016

- Rectangular lunch box
- Includes round inner box

Dimensions:

16cm (l) x 12.5cm (w) x 5.8cm (h)
780ml capacity

ROUND LUNCH BOX



CODE: SUP152312 | 12cm d. | 700mL

CODE: SUP152314 | 14cm d. | 1.1L

TIERED LUNCH BOX



CODE: SUP152042

- Two tier oval lunch box
- Includes inner box
- Sturdy lock, foldable handle

Dimensions:

14cm diameter | 1.1L capacity

TIERED FOOD CARRIER



CODE: SUP150103 | 10cm dia. | Three tier food carrier

CODE: SUP150122 | 12cm dia. | Two tier food carrier

CODE: SUP150142 | 14cm dia. | Two tier food carrier

WATER CONTAINERS



ROUND PLASTIC BASIN



CODE: PCR

Dimensions:
- 30mm (dia.) x 120mm (h)
- Volume: 8L



RECTANGLE PLASTIC BASIN



CODE: PCS

Dimensions:
- 300mm (d) x 360mm(w) x 120mm (h)
- Volume: 9L

COLLAPSIBLE CONTAINER



CODE: CWC10 | Volume: 10L
CODE: CWC20 | Volume: 20L

WATER CUBES



CODE: PC15 | Volume: 15L
- Made from food grade HDPE
- BPA free



CODE: PC20 | Volume: 20L
- Made from food grade HDPE
- BPA free



CODE: PC25 | Volume: 25L
- Made from food grade HDPE
- BPA free

WATER JERRY CANS



CODE: AT5 | Volume: 5L
CODE: AT10 | Volume: 10L
- Food grade HDPE, BPA free



CODE: AT20 | Volume: 20L
- Food grade HDPE, BPA free



CODE: AT20G | Volume: 20L
- Food grade HDPE, BPA free
- Heavy duty

FUEL CONTAINERS | ACCESSORIES



FUEL DRUMS



CODE: J5 | Volume: 5L
CODE: J10 | Volume: 10L

- Fully approved fuel container; red
- Fully approved diesel container; yellow



CODE: J20C | Volume: 20L | Red
CODE: J20F | Volume: 20L | Yellow



UNIVERSAL ON/OFF TAP



CODE: PCT

CAP AEROFLOW TAP



CODE: PCAFC
- To suit water cube



ON/OFF SNAP TAP



CODE: SNT | Single item
CODE: SNT1 | Prepacked

BUNG AEROFLOW TAP



CODE: PCAFB
- To suit water cube and/or jerry can



UNIVERSAL BUNG



CODE: PCB



DRUM SPANNER



CODE: SPA
- Assists opening water cube caps & bungs



CAP



CODE: PCC
- To suit water cube

BEACH & SHELTERS



INFLATABLE RIDERS
_____ 107

INFLATABLE LOUNGES
_____ 109

BOAT SETS
_____ 110

PUMPS
_____ 111

OAR SETS
_____ 111

TENTS & SHELTERS
_____ 112

INFLATABLE RIDERS

MUD MASTER SWIM RING

CODE: SUP36106

- Colour shield printing
- Sturdy pre-tested vinyl construction
- Includes safety valve

Dimensions:

Inflated - 91cm dia.



HIGH VELOCITY TYRE TUBE

CODE: SUP36102

- Realistic tyre printing
- Sturdy pre-tested vinyl construction
- Heavy duty handles
- Includes repair patch
- Includes safety valve

Dimensions:

Inflated - 119cm dia.



SINGLE SEAT LUXURY INFLATABLE

CODE: SUP43116

- Inflata-Shield™ material resists puncture, limits stretching and enhances grip
- Premium construction includes backrest & wraparound grab rope
- Cool mesh bottom
- Heavy duty handles
- Two cup holders
- Interlocking quick release valves
- Includes repair patch
- Weight Rating: 90kg

Dimensions:

Inflated - 122cm (dia.) x 48.5cm (h)

Deflated - 135cm (dia.)



INFLATABLE RIDERS

ALPINE COOLER TUBE

CODE: SUP43398

- Wrap around grab rope with built in grommets
- Premium construction with back rest
- Cool mesh bottom
- Includes insulated cooler bag
- One cup holder
- Weight Rating: 90kg

Dimensions:

Deflated - 169cm (l) x 137cm (d)

Inflated - 159cm (l) x 53cm (w) x 126cm (d)



DOUBLE SEAT INFLATABLE RIDER

CODE: SUP43113

- Inflata-Shield™ material resists puncture, limits stretching and enhances grip
- Premium construction includes backrest & grab rope
- Pliable mesh bottom with heavy duty handles
- Built-in inflatable cooler & storage compartment
- Interlocking quick release valves
- Includes repair patch
- Weight Rating: 180kg

Dimensions:

Inflated - 122cm (d) x 240cm (w) x 50cm (h)

Deflated - 132cm (d) x 251cm (l)



SUN SOAKER FLOATING PLATFORM

CODE: SUP43542

- Inflata-Shield™ material resists puncture, limits stretching and enhances grip
- Extra wide pillows; interlocking quick release valves
- Four Clasp 'N' Go™ buckles to connect multiple platforms
- Includes repair patch
- Weight Rating: 360kg

Dimensions:

Inflated - 269cm (d) x 183cm (w) x 25cm (h)

Deflated - 290cm (d) x 191cm (l)



INFLATABLE LOUNGES

SOL VENTURE MESH LOUNGE

CODE: SUP43540

- Inflata-Shield™ material resists puncture, limits stretching and enhances grip
- Premium construction includes headrest
- Cool mesh bottom
- One cup holder
- Includes repair patch
- Weight Rating: 90kg

Dimensions:

Inflated - 188cm (d) x 109cm (w) x 46cm (h)

Deflated - 198cm (d) x 119cm (l)



INDIGO WAVE LOUNGE

CODE: SUP43533

- Inflata-Shield™ material resists puncture, limits stretching and enhances grip
- Premium construction includes headrest and armrests
- One cup holder
- Includes repair patch
- Weight Rating: 90kg

Dimensions:

Inflated - 183cm (d) x 97cm (w) x 53cm (h)

Deflated - 191cm (d) x 107cm (l)



INDIGO WAVE DOUBLE LOUNGE

CODE: SUP43534

- Inflata-Shield™ material resists puncture, limits stretching and enhances grip
- Includes headrest & armrests for each lounger
- Two cup holders; interlocking quick release valve
- Includes repair patch
- Weight Rating: 180kg

Dimensions:

Inflated - 183cm (d) x 176cm (w) x 56cm (h)

Deflated - 196cm (d) x 193cm (l)



BOAT SETS

SINGLE SEAT BOAT SET

CODE: BT1

- Single seat inflatable boat; inflatable floor for comfort
- Features: tow ring & tow rope, built-in grommets
- Weight Rating: 80kg

Dimensions:
107cm (w) x 165cm (l)



DOUBLE SEAT BOAT SET

CODE: BT2

- Double seat inflatable boat; inflatable floor for comfort
- Features: tow ring & tow rope, built-in grommets, oar clasps
- Includes oar set & foot pump

Dimensions:
115cm (w) x 197cm (l)



PUMPS | OAR SETS

12V AIR PUMP



CODE: PP1

240V AIR PUMP



CODE: PP2

FOOT BELLOWS



CODE: PP3

- Foot bellows, 5000CC

PUSH/PULL PUMP



CODE: PP4

- 13000CC
- Inflates/deflates on up/down stroke

PLASTIC OAR SET



CODE: OAR1

- Plastic oar set with ribbed blade
- Three section structure for easy assembly

ALUMINIUM OAR SET



CODE: OAR2

- Sectional aluminium oar set
- Can be used as one twin blade paddle; 2.18m (l)
OR two single blade paddles, each 1.45m (l)

COOL QUICK 2 TENT

CODE: SUP68097

- Single layer pop up tent
- One entrance, 3 ventilation openings
- One pole structure for easy pitching and folding
- Set up time: 3 mins
- Capacity: 2 people
- Fabric: 180T polyester PU coated
- Ground protection: 110g/m² PE
- Guy rope: polyester



COOL DOME 3 TENT

CODE: SUP68085

- Single layer
- One entrance
- Set up time: 8 mins
- Capacity: 3 people
- Fabric: 190T polyester PU coated
- Ground protection: 110g/m² PE
- Guy rope: polyester



COOL MOUNT 2 TENT

CODE: SUP68086

- Single layer pop up tent
- One entrance, 2 side windows
- Set up time: 3 mins
- Capacity: 2 people
- Fabric: 190T polyester PU coated
- Ground protection: 120g/m² PE
- Guy rope: polyester



COOL MOUNT 4 TENT

CODE: SUP68087

- Single layer pop up tent with improved ventilation
- One entrance, two side windows
- Setup time: 3 mins
- Capacity: 4 people
- Fabric: 190T polyester PU coated
- Ground protection: 120g/m² PE



ACTIVE MOUNT 3 TENT

CODE: SUP68090

- Double layer, double entrance, stocking area with extra floor
- Set up time: 15 mins
- Capacity: 3 people
- Outer tent fabric: 190T polyester PU coated
- Inner tent fabric: 190T breathable polyester
- Ground protection: 120g/m² PE
- Guy rope: polyester



BEACH TENT

CODE: SUP68105

- Simple set up
- includes carry bag for easy transport
- Capacity: 2 people
- Fabric: 190T polyester PA coated
- Ground protection: 100g/m² PE



SECURA BEACH TENT

CODE: SUP68107

- Sets up in seconds
- Protection from sun with UPF40+ rating
- Capacity: 2 people
- Fabric: 190T polyester PA silver coated
- Ground protection: 120g/m² PE

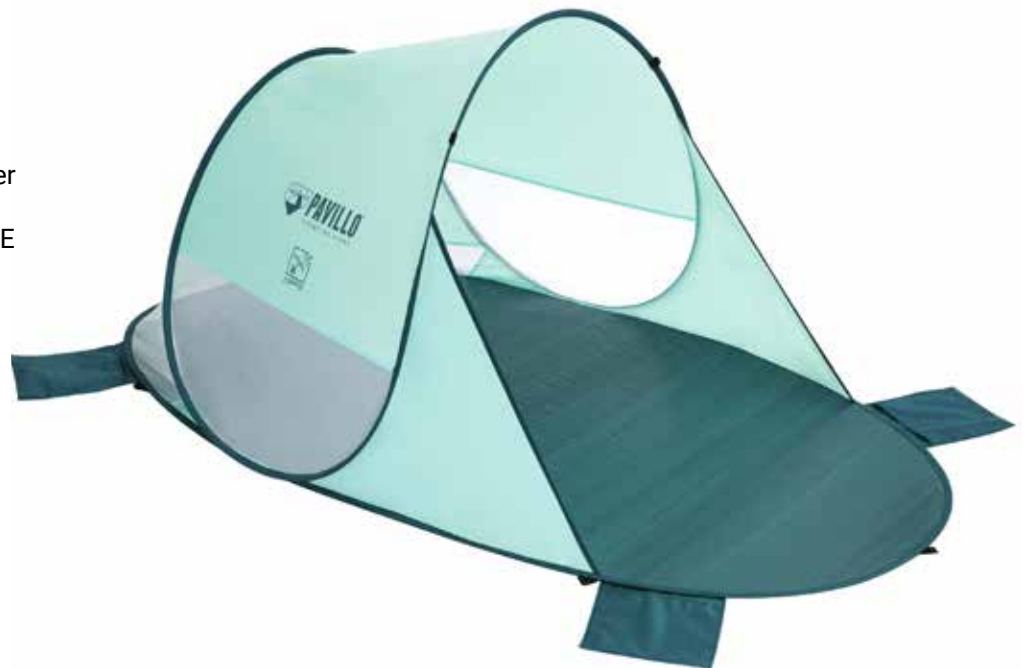

RAMBLE X2 TENT

CODE: SUP68001

- Easy to set up and convenient to carry
- Capacity: 2 people
- Fabric: 170T polyester PA coated
- Ground protection: 110g/m² PE



STATION PORT CHANGING STATION

CODE: SUP68002

- Offers privacy by the beach, lake or pool
- Two side windows and removable floor drain
- Capacity: 1 person
- Fabric: 170T polyester PA Coated
- Ground protection: 110g/m² PE



CAMPSITE ACCESSORIES

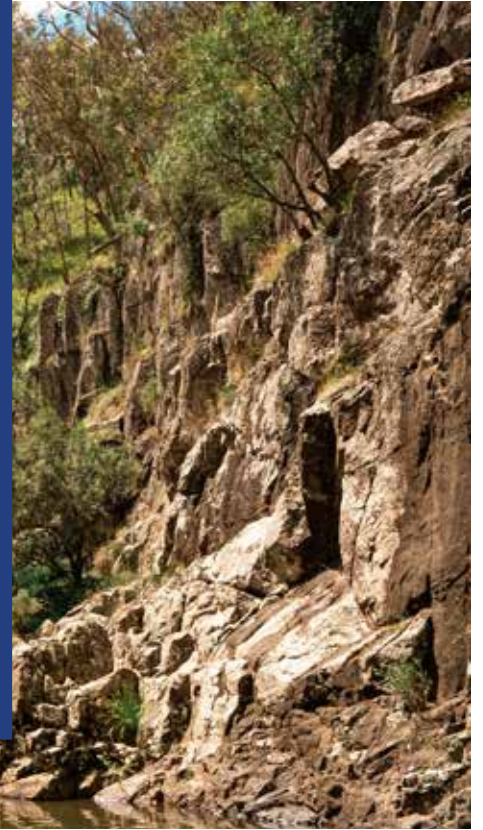

SHOWERS
_____ 117

12V ACCESSORIES
_____ 117

CAMPING IMPLEMENTS
_____ 118

CAMPS 12 BOOKS
_____ 119

SHOWERS | 12V ACCESSORIES



SOLAR SHOWER



CODE: SOL1 | Solar Shower
- Capacity: 20L



CANVAS SHOWER



CODE: 40BSC | Canvas bucket only
CODE: 41BSC | With plastic rose
- Canvas bucket shower with or without plastic shower rose
- Capacity: 20L

SHOWER ROSE



CODE: 80BR
- Plastic rose, 80mm dia.

12V OUTDOOR CAMPING FAN



CODE: CF01
- 270° fan with LED, night & SOS lights
- 3 fan settings, 3 light settings
- Run time: 5 - 12 hours
Product Weight: 890g

Dimensions:
215mm (w) x 245mm (h) x 80mm (d)

12V AIR PUMP



CODE: AP01
- Compact, portable & rechargeable
- With hanging hook and LED light
- Powerful air flow: 200-250L/m
Product Weight: 162g

Dimensions:
50mm (w) x 89mm (h) x 55mm (d)

12V CAMPING LIGHT



CODE: HL08
- Multipurpose light with 6 modes
- Use closed, partly or fully opened
- Includes hook and carry bag
Product Weight: 420g / IPX5

Dimensions:
55mm (w) x 220mm (h) x 55mm (d)

CAMPSITE IMPLEMENTS



FIXED SHOVEL



CODE: SHV1
- Fixed handle shovel
- Wooden handle, 750mm (l)

FOLDING SHOVEL



CODE: SHV2
- Tri-fold metal handle shovel
- Includes carry bag

MALLET



CODE: MAL
- Stone hammer
- Weight: 1.2kg
- Fibreglass handle, 230mm (l)

CAMPING HATCHET



CODE: HTC1
- Camping hatchet
- Weight: 0.6kg
- Fibreglass handle, 300mm (l)

MINI SPLITTER



CODE: MISP
- Mini block splitter / stone hammer
- Weight: 1.75kg
- Fibreglass handle, 330mm (l)



CAMPS 12 AUSTRALIA WIDE

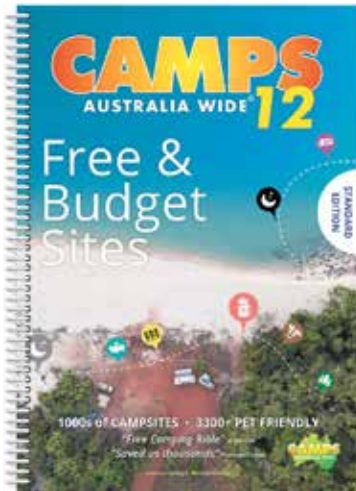

CODE: C12A4 | Camps 12 Australia Wide - A4 size

CODE: C12B4 | Camps 12 Australia Wide - B4 size

- Definitive guide to low-cost camping across Australia
- Identify site types by symbol
- Includes fold out map of Australia
- Updated site listings including dump points, facilities, free and paid sites, powered and non-powered sites, pet allowances
- Ring bound and printed in Australia
- Features HEMA road atlas maps, with GPS coordinates and street addresses
- State by state indexation

Note: B4 size contains images of every campsite

CARAVAN PARKS 5 AUSTRALIA WIDE

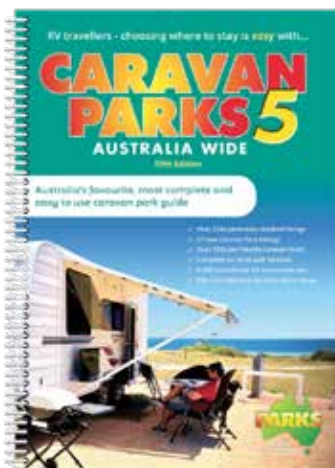

CODE: CPA4 | Caravan Parks 5 Australia wide - A4 size

- Comprehensive yet concise caravan parks guide
- Over 2,220 tourist and caravan parks listed and verified
- Each site listing contains detailed location and facility information
- Includes fold out map of Australia
- Features HEMA road atlas maps and GPS coordinates
- Perfect for use in conjunction with the Camps 12 books
- Printed and ring bound in Australia

CAMPS COMMUNITY COOKBOOK

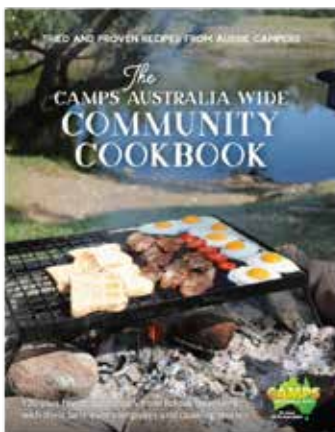

CODE: CACC | Camps Community cookbook

- The perfect kitchen companion on all adventures
- A uniquely Australian cookbook full of tried and true recipes generously provided by the CAMPS community
- Versatile range of recipes for camp ovens, BBQs, gas stoves, microwaves, thermal and slow cookers
- Features contributors 'best ever' campsites and caravan parks, recommended 'must see and do' and camp memories and stories
- Printed in Australia

Dimensions:

190mm (w) x 245mm (h)

A

A-TYPE BEARING SET P33
 ACTION CHAIRS P91
 ADJUSTABLE ACCESSORIES P31
 ADJUSTABLE GAS BOTTLE HOLDER P33
 ADJUSTABLE LEGS P30
 ADJUSTABLE STANDS P30
 AIR BEDS, VELOUR P87
 AIR PUMP, 12V P117
 AIR PUMPS P111
 AIRER, FOLDING P12
 ALPINE COOLER TUBE P108
 ALUMINIUM DIRECTORS CHAIR P92
 ALUMINIUM FOOT P31
 ALUMINIUM SPREADER BARS P67
 ALUMINIUM TENT POLES P66
 ANNEXE MATTING, CARAVAN P20
 ANODE P51
 AWNING BRACKET P42
 AWNING LIGHT-PC P53
 AWNING ROPE CLIP PACK P40
 AWNING ROPE CLIPS P40
 AWNING ROPE CRADLE BOX PACK P40
 AWNING ROPE CRADLE PAIR P40
 AWNING ROPE CRADLE POLE PACK, BLACK P41
 AWNING ROPE CRADLE POLE PACK, WHITE P41
 AWNING TENSIONER P42

B

BAG, ELECTRICAL LEAD P11
 BAG, HOSE LARGE P11
 BAG, HOSE SMALL P11
 BAG, TENT PEG P75
 BAG, TENT POLE P73
 BARGMAN STYLE LIGHT P53
 BASINS P104
 BASKET, COLLAPSIBLE P19
 BEACH & SHELTERS P106
 BEACH CHAIR P92
 BEARINGS P33
 BEDDING P86
 BILLY TEA POT, ZEBRA P101
 BIRD BEAK & PLATE P69
 BOAT SETS P110
 BONUS DROP PRIVACY SCREEN P44
 BOW ENDS P70
 BOW KNUCKLE P69
 BOW MOUNT P69
 BOW SHACKLES P33
 BOWL, COLLAPSIBLE P17
 BOWL, ZEBRA P100
 BRIGHT BAR LIGHT P52
 BUCKET, COLLAPSIBLE P19
 BUNGEE CORD P79

C

CAMLOK P70
 CAMP & OUTDOORS P58
 CAMP BLUE, STIMEX P46
 CAMP FLUSH, STIMEX P46
 CAMP GREEN, STIMEX P46
 CAMP QUAD CHAIR P91
 CAMP SOFT P47
 CAMPER CLEANER P83
 CAMPING FAN, OUTDOOR 12V P117
 CAMPING HATCHET P118
 CAMPING LIGHT, 12V P117
 CAMPING SET, ZEBRA P102
 CAMPS COMMUNITY COOKBOOK P119
 CAMPS12 AUSTRALIA WIDE P119
 CAMPSITE ACCESSORIES P116
 CANVAS ACCESSORIES P82
 CANVAS BUCKET PG 115
 CANVAS BUCKET SHOWER P117
 CANVAS TO CANVAS T TOGGLE P82
 CARAVAN ACCESSORIES P22

CARAVAN ANNEXE MATTING P20
 CARAVAN AWNING & ACCESSORIES P36
 CARAVAN AWNING SAFETY STRAPS P42
 CARAVAN FILTER P25
 CARAVAN FRIDGE SCREEN P45
 CARAVAN LEADS P51
 CARAVAN PARKS 5 AUSTRALIA WIDE P119
 CARAVAN SINK PLUG P24
 CASSETTE TANK CLEANER P47
 CHAIRETTE P94
 CLAMP P29
 CLIP ON TOWING MIRROR P24
 CLOTHES AIRERS P12
 CLOTHESLINE, EASY HANG P12
 CLOTHESLINE, PEGLESS P12
 COILS, MINI P76
 COLANDER, COLLAPSIBLE P17
 COLLAPSIBLE CHAIR P91
 COLLAPSIBLE CONTAINERS P16, 104
 COLLAPSIBLE COOKWARE P16
 COMBINATION LAMPS, REAR P56
 COMBINATION LAMPS, SLIMLINE P55
 COMBINATION LAMPS, SLIMLINE REAR PG 54
 COMBO SLIDE P78
 COOKBOOK, CAMPS COMMUNITY P119
 COOKWARE P96
 COUPLING LOCK, TWIN P33
 CURVED ROOF RAFTERS P38
 CURVED ROOF RAFTERS, SPARE PARTS P39

D

D RINGS P82
 D SHACKLES P33
 DE FLAPPER P40
 DELUXE OFFROAD 4WD MAT P87
 DIRECTORS CHAIRS P92
 DISH DRAINER, COLLAPSIBLE P17
 DISPLAY BOX, POP TOP SUPPORT BAR P23
 DOUBLE SEAT BOAT SET P110
 DOUBLE SEAT INFLATABLE RIDER P108
 DRINKING WATER HOSE FITTINGS P10
 DRINKING WATER HOSE P810
 DUAL AXLE WHEEL CHOCK P9
 DUAL AXLE WHEEL LEVELLING RAMP P9
 DUTCH OVEN LID LIFTER P97
 DUTCH OVENS P97

E

EASY FIT TOWING MIRROR P24
 EASY HANG CLOTHESLINE P12
 ELASTIC SHOCK CORD WITH HOOK P79
 ELECTRICAL & 12V P50
 ELECTRICAL LEAD BAG P11
 END WALL PRIVACY SCREEN P43
 ENSUITE P46
 EVADE SLEEPING BAGS P88
 EXTENSION TENT POLES P61
 EXTERIOR LED LIGHTING P53
 EXTERNAL POLE CAP P69
 EXTRA FLEXIBLE SULLAGE HOSE P10

F

FASTENER HOOK P77
 FIAMMA PRIVACY SCREEN P45
 FILTER, CARAVAN P25
 FIRST AID KIT P25
 FITTINGS, DRINKING WATER HOSE P10
 FITTINGS, SULLAGE HOSE P11
 FIVE POSITION HARD ARM CHAIR P92
 FIX N ZIP P85
 FLAT PLUG, 7 PIN P51
 FLAT SOCKET, 7 PIN P51
 FLEXIBLE SULLAGE HOSE, EXTRA P11
 FOLD IN HALF TABLE P95
 FOLDING AIRER P12
 FOLDING DIRECTORS CHAIR P92

FOLDING STOOLS P94
FOOT BELLOWS P111
FOOT, ALUMINIUM P31
FOOT, PLASTIC P31
FRIDGE SCREEN, CARAVAN P45
FRYPAN, COLLAPSIBLE P18
FRYPANS P98
FUEL DRUMS P105
FURNITURE P90

G

GAS BOTTLE HOLDERS P35
GAS BOTTLE HOLDERS, ADJUSTABLE P35
GRIDDLE PANS P98

H

HAIR DRYER P51
HAIR STYLER P51
HAND PUMP, SINK P25
HANDLE ROLL PIN P29
HATCHET, CAMPING P118
HIBERHIDE SLEEPING BAGS P89
HIGH VELOCITY TYRE TUBE P107
HIKER SELF INFLATING MATTRESS P87
HOLD TIGHT TARP GRIPPER P79
HOOK & LOOP TAPE P81
HOOK, SHOCK CORD P79
HOOP LEG STOOL P94
HORIZONTAL T TOGGLE P82
HOSE BAG, LARGE P11
HOSE BAG, SMALL P11
HOSE, DRINKING WATER FITTINGS P10
HOSE, DRINKING WATER P10
HOSE, SULLAGE FITTINGS P11
HOSE, SULLAGE P10

I

INDIGO WAVE DOUBLE LOUNGE P109
INDIGO WAVE LOUNGE P109
INFLATABLE RIDERS P107
INTERIOR LED LIGHTING P52
INTERNAL POLE CAP P69

J

JACK PAD, CARAVAN P32
JACK PAD, STACKER P32
JAFFLE IRONS P99
JAYCO, POP TOP SUPPORT BAR P23
JERRY CAN HOLDERS P34
JOCKEY WHEEL HOLDER, LARGE P29
JOCKEY WHEELS P27

K

KETTLE, COLLAPSIBLE P18
KIDS ACTION CHAIR P91
KING SIZE ACTION CHAIR P91
KNOB, SHOCK CORD P79

L

LADDER LOCK P82
LADDER STRAP, RUBBER P42
LARGE HOSE BAG P11
LARGE JOCKEY WHEEL HOLDER P29
LARGE RUBBER WHEEL HOLDER P29
LEADS, CARAVAN P51
LEAK REPAIR P83
LED LIGHTING P52
LED LIGHTING, EXTERIOR P53
LED LIGHTING, INTERIOR P52
LEGS, ADJUSTABLE P30
LEVEL, RV BLOCK SET P7
LEVELLING RAMP, DUAL AXLE P7
LEVELLING RAMP, SINGLE AXLE P7
LID LIFTER, DUTCH OVEN P97
LIGHT, CAMPING 12V P117
LONG WALL PRIVACY SCREEN P43

LOOP HANDLE POT, ZEBRA P101
LOOP, SHOCK CORD P79
LUNCH BOX ROUND, ZEBRA P103
LUNCH BOX, ZEBRA P103
LUXURY INFLATABLE, SINGLE SEAT P107

M

MAGAZINE HOLDER P24
MAINTENANCE & REPAIR P80
MALLETT P118
MARKER LAMPS P57
MARQUEE POLE P63
MATTING, CARAVAN ANNEXE P20
METAL SLIDES P73
MIGHTY HIKER CHAIR, WANDERLITE P93
MINI COILS P78
MINI SPLITTER P118
MIRROR, CLIP ON TOWING P24
MIRROR, EASY FIT TOWING P24
MOUNTING BRACKETS P23
MUD MASTER SWIM RING P107
MUG, ZEBRA P100
MUG, ZEBRA WITH LID P100

N

NOMAD TABLE, WANDERLITE P93
NUMBER PLATE LAMP P53

O

OAR SETS P111
OUTDOOR CAMPING FAN, 12V P117
OUTDOOR SPRAY P83
OYSTER LIGHT P52

P

PEGGY PEG P76
PEGLESS CLOTHESLINE P12
PERSONAL TABLE P93
PIN FOR REPLACEMENT FOOT P31
PLASTIC FOOT P31
PLASTIC POLE GROUND PLATE P70
PLASTIC SAND PEGS P74
PLASTIC SLIDE ROPE KIT P73
PLASTIC SNAP CLIP P69
PLASTIC TENT PEGS, HANG SELL PG75
PLATE, ZEBRA P100
PLUG, 7 PIN FLAT P51
PLUG, CARAVAN SINK P24
POLE CLAMP P70
POLE HOLDER P22
POLY WEBBING P81
POLYMER SLIDE P78
POLYMER SLIDE ROPE KIT P73
POLYPROPYLENE ROPE PG78
POP TOP PRIVACY SCREEN P44
POP TOP SUPPORT BAR DISPLAY BOX P23
POP TOP SUPPORT BAR JAYCO P23
POP TOP SUPPORT P23
PORTA PAK TOILET CHEMICAL P47
PORTABLE TOILET P49
PRIVACY SCREEN, BONUS DROP P44
PRIVACY SCREEN, END WALL P43

PRIVACY SCREEN, FIAMMA P45
PRIVACY SCREEN, LONG WALL P43
PRIVACY SCREEN, POP TOP P45
PRIVACY SCREENS P43
PROPPOWER PROBIOTIC TOILET CHEMICAL P49
PULLER, TENT PEG P75
PUMP, SINK HAND P25
PUMPS & ACCESSORIES P111

Q

QUICK ACTION CLAMP P70

R

READING LIGHT P52
RECTANGLE CONTAINERS- FOUR PACK P14
RECTANGLE CONTAINERS- TWO PACK P14
RETAIL PACK, TEAR AID P84
ROOF RAFTER END P39
ROOF RAFTER END P39
ROOF RAFTERS, CURVED P38
ROOF RAIL BRACKET P70
ROOF RAILS P65
ROPE CLIP PACK, AWNING P40
ROPE CLIPS, AWNING P40
ROPE CRADLE, AWNING PACKS P40, 41
ROPE CRADLE, AWNING PAIR P40
ROPE SLIDE, WIRE P78
ROPE, WHITE & SILVER P78
ROPES & PEGS P72
ROUND CONTAINERS- FOUR PACK P14
RUBBER LADDER STRAP P42
RUBBER RING P35
RUBBER TYRE P27
RUBBER WHEEL HOLDER P29
RUBBER WHEEL HOLDER, LARGE P29
RUBBER WHEEL, SOLID P29
RV & TRAILER HARDWARE P26
RV ESSENTIALS & ACCESSORIES P8
RV LEVEL BLOCK SET PG9

S

SACHETS, TOILET CHEMICAL P47
SAFETY POWER BLOCK P49
SAFETY STRAPS, CARAVAN AWNING P42
SAUCEPAN, COLLAPSIBLE P18
SAUCEPANS P99
SEAM SEALER P83
SEAT BELT WEBBING P81
SECURA BAR P37
SECURA BAR SPIGOT END P39
SECURA BAR, SPARE PARTS P37
SELF ADHESIVE ROLLS P79
SELF INFLATING MATS P87
SHACKLES, BOW P33
SHACKLES, D P33
SHELTERS P110
SHOCK CORD HOOK P79
SHOCK CORD KNOB P79
SHOCK CORD LOOP P79
SHOCK CORD P79
SHOVELS P118
SHOWER, CANVAS BUSH P117
SHOWER, SOLAR P117
SIDE RELEASE BUCKLES P82

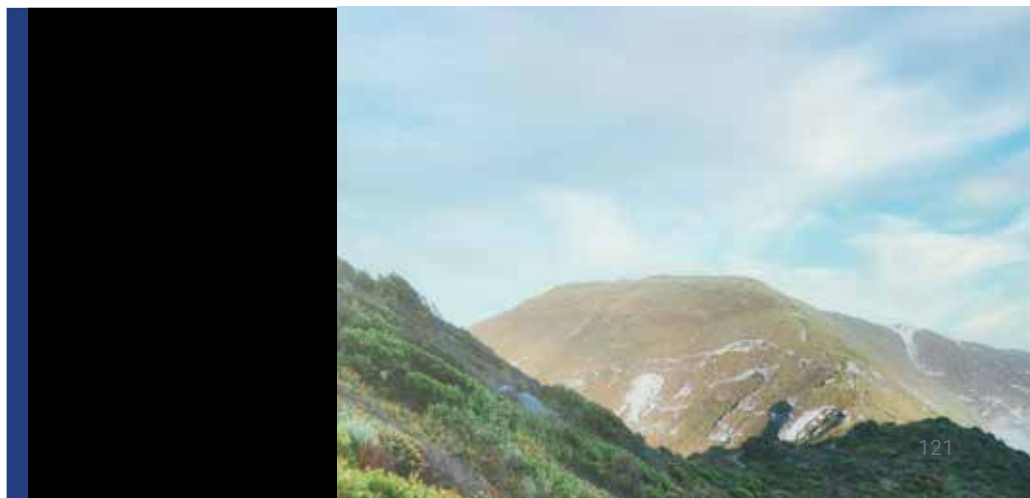

S (CONTINUED)

SINGLE AXLE WHEEL LEVELLING RAMP P9
SINGLE SEAT BOAT SET P110
SINGLE SEAT INFLATABLE P105
SINK HAND PUMP P25
SINK PLUG, CARAVAN P24
SLAT TABLE P95
SLEEPING BAGS P88
SLIDES P71
SLIMLINE COMBINATION LAMPS P54
SMALL FOLD IN HALF TABLE P95
SMALL HOSE BAG P9
SNAP CLIP, PLASTIC P69
SOCKET, 7 PIN FLAT P51
SOL VENTURE MESH LOUNGE P109
SOLAR SHOWER P117
SOLID RUBBER WHEEL P29
SPIGOT DOME & SPRING P70
SPIGOT DOME P70
SPIGOT P68
SPIGOT, 6MM PIN P68
SPIGOT, BENT P68
SPIGOT, HOOK BENT P68
SPIGOT, JAYCO BENT P68
SPIGOT, LONG P68
SPIGOT, S BEND P668
SPIGOT, SOLID ALUMINIUM P68
SPIGOT, THREADED P68
SPLICE CLIP P70
SPLITTER, MINI P118
SPREADER BARS P64
SPREADER BARS, ALUMINIUM P67
SPRING BUTTON CLIP P70
SQUARE C CLIP SUPPORT CLIP P69
STAINLESS STEELWARE, ZEBRA P100
STANDS, ADJUSTABLE P30
STARTER PACKS, CARAVAN P13
STEEL DIRECTORS CHAIR P92
STEEL TENT PEGS P74
STEPS, CARAVAN P14
STIMEX CASSETTE TANK CLEANER P47
STIMEX FABRIC TREATMENT P81
STIMEX TOILET CHEMICAL LIQUID P48
STIMEX WATER TANK CLEANER P47
STOCK POT, ZEBRA P102
SULLAGE HOSE FITTINGS P11
SULLAGE HOSE P10
SULLAGE HOSE, EXTRA FLEXIBLE P11
SUN SOAKER FLOATING PLATFORM P108
SUPER KING SIZE ACTION CHAIR P91
SUREMAT P21
SWAG POLE P62
SWIM RING, MUD MASTER P105
SWIVEL RAIL LIGHT P52

T

T LEVEL P24
T NUT & THUMBSCREW P70
T TOGGLE, CANVAS TO CANVAS P82
T TOGGLE, HORIZONTAL P82
T TOGGLE, VERTICAL P82
TABLES P95
TAPS, WATER & FUEL CONTAINERS P105
TARPS, TORNADO P69
TEAR AID P84
TENT CLEANER P83

TENT PEG BAG P75
TENT PEG PULLER P75
TENT PEGS, PLASTIC SAND P74
TENT PEGS, STEEL P74
TENT POLE ACCESSORIES P68
TENT POLE BAG P73
TENT POLES & SPREADER BARS P60
TENT POLES P61
TENT POLES, ALUMINIUM P66
TENTS P112
TIE DOWN KIT P45
TIERED FOOD CARRIER, ZEBRA P103
TIERED LUNCH BOX, ZEBRA P103
TIMBER SLIDE P78
TIMBER SLIDE ROPE KIT P73
TOASTERS P99
TOILET CHEMICAL LIQUID, STIMEX P48
TOILET CHEMICAL SACHETS P47
TOILET PAPER, CAMP SOFT P49
TOILET, PORTABLE P49
TORNADO TARPS P71
TOUR & RV P6
TOWING MIRROR, CLIP ON P24
TOWING MIRROR, EASY FIT P24
TRACE SPRINGS P78
TRAILER ACCESSORIES P33
TREKWAY SELF INFLATING MAT P87
TRI LEG STOOLS P94
TRIGLIDES P82
TRIPODS P97
TUBS, COLLAPSIBLE P19
TWIN COUPLING LOCK P33
TYRE, RUBBER P29

U

ULTRA HIKER CHAIR, WANDERLITE P93
ULTRA SLIM LIGHT P52
UTILITY TABLE P95

V

VELOUR AIR BEDS P87
VENETIAN BLIND CORD P78
VERTICAL T TOGGLE P82
VOYAGER CHAIR, WANDERLITE P93

W

WANDERLITE LIGHTWEIGHT FURNITURE P93
WASH TUB/SINK, COLLAPSIBLE P19
WATER CONTAINERS P104
WATER CUBES P104
WATER JERRY CANS P104
WATER TANK CLEANER P47
WATER, DRINKING HOSE P10
WATERPROOFER P83
WEBBING, POLY P81
WHEEL CHOCK P9
WHEEL CHOCK, DUAL AXLE P9
WHEEL LEVELLING RAMP, DUAL AXLE P7
WHEEL LEVELLING RAMP, SINGLE AXLE P9
WHEEL RAMPS & CHOCKS P9
WHEELS, JOCKEY P27
WHISTLING KETTLE, ZEBRA P101
WHITE & SILVER ROPE P78
WINDOW BRACKET P69

WIRE ROPE SLIDE P78
WORKSHOP PACK, TEAR AID P84

X

Y

Z

ZEBRA STAINLESS STEELWARE P100



PHOTOGRAPHY LOCATIONS & ATTRIBUTIONS

Page 2 | Outback, South Australia | Photo by [Jay Wennington](#) on [Unsplash](#)
Page 4 | Blackdown, Queensland | Photo by [AJ Green](#) on [Unsplash](#)
Page 6 | Exmouth, Western Australia | Photo by [Amanda Klamrowski](#) on [Unsplash](#)
Page 8 | Millaa Millaa, Queensland | Photo by [Bailey Cullen](#) on [Unsplash](#)
Page 26 | Narrandera, New South Wales | Photo by [Ethan Cull](#) on [Unsplash](#)
Page 36 | Laurieton, New South Wales | Photo by [Debbie Ducic](#) on [Unsplash](#)
Page 46 | Sydney, New South Wales | Photo by [Tristan Bracewell](#) on [Unsplash](#)
Page 50 | Outback, Northern Territory | Photo by [Nicole Richstein](#) on [Unsplash](#)
Page 58 | Flinders Ranges, South Australia | Photo by [Megan Clark](#) on [Unsplash](#)
Page 60 | Mingary, South Australia | Photo by [Trevar Skillicorn-Chilver](#) on [Unsplash](#)
Page 72 | Wineglass Bay, Tasmania | Photo by [Tim Hart](#) on [Unsplash](#)
Page 80 | Kings Canyon Access, Northern Territory | Photo by [Christian Bass](#) on [Unsplash](#)
Page 86 | Nymagee, New South Wales | Photo by [Megan Clark](#) on [Unsplash](#)
Page 90 | Parachilna, South Australia | Photo by [Michael SKOPAL](#) on [Unsplash](#)
Page 96 | Bobs Farm, New South Wales | Photo by [Silas Baisch](#) on [Unsplash](#)
Page 106 | Devonport, Tasmania | Photo by [Josh Arnott](#) on [Unsplash](#)
Page 116 | Lindesay, New South Wales | Photo by [Anna Cheng](#) on [Unsplash](#)
Page 120 | Bald Head, Western Australia | Photo by [Davide Pietralunga](#) on [Unsplash](#)
Page 123 | Great Ocean Road, Victoria | Photo by [Stefan K](#) on [Unsplash](#)





**DISTRIBUTORS OF QUALITY PRODUCTS
FOR THE CARAVAN & LEISURE INDUSTRY**

**PHONE: 02 4823 6001
EMAIL: SALES@SUPEX.COM.AU**

**9 LOCKYER STREET
GOULBURN NSW 2580
PO BOX 215
GOULBURN NSW 2580**